

Switches Sockets and Accessories Product Information and Price List



Company Overview

A Professional of electrical switchgear, Norisys constructs innovative switchgear systems and has established itself by many years of experience and high quality workmanship. Norisys is committed to being recognised as a premier destination for electrical products.

Each day Norisys engineers work to bring about a combination of innovative designs and materials using advanced manufacturing technology in order to create products that are best suited to meet user requirements.

We continuously strive to upgrade processes and materials. CUBE Series and SQUARE Series products thus ensure sound electrical performance.

Products such as Modular MCBs, Single Phase Motor Starters, Power Units for airconditioners are all products made by Norisys, and have today become common household products. Quality is ensured at every stage.

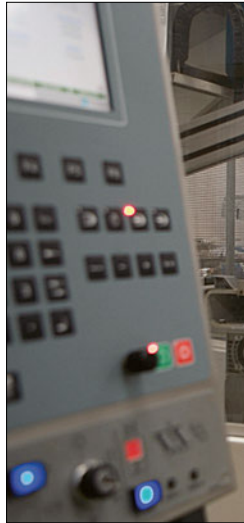

The manufacturing plant is equipped with modern state-of-the-art machinery and equipment. In-house facilities for testing and quality assurance of all components ensure guaranteed quality. Extensive material selection process and rigorous quality monitoring process is followed for conformity to highest standards.

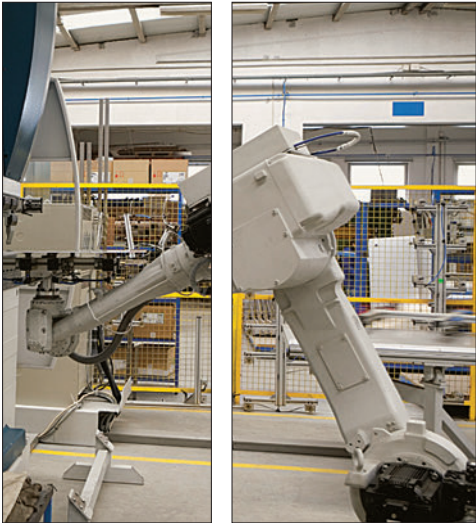

All products from Norisys have been developed to establish new standards in electrical accessories. Commitment to superior designs, elaborate attention to engineering details, modern manufacturing facilities and stringent quality measures have combined together to create a new concept in safety, reliability, flexibility and modernity.

Norisys has a full fledged, well equipped research and development division which works constantly to improve, innovate and engineer new products. This research and development division has a fully integrated product development environment that directs the development process throughout - right from conceptual design to manufacturing.

All Norisys products are designed for extreme endurance. Materials are chosen to withstand arduous conditions. Local wiring practices are carefully studied before designing any new product at Norisys. This ensures ease of installation and durability of the products.

Bi-material Frames engineered for toughness

CUBE Series products are designed for tough performance. The products are mounted in a way that the entire pressure of wires in the junction box is borne entirely by a sturdy bi-material frame.

4

The bi-material support frames in CUBE Series is the result of several man-hours of research and development. The bi-material frames are made of a combination of steel and engineering grade plastic. In this design, the steel structure is embedded into plastic. The steel inside gives the bi-material frame a rigid structure while the plastic provides the anti-rust and insulation properties.

Modules are mounted on the bi-material frames using a unique snap-fit mechanism. This snap-fit mechanism is highly accurate thereby ensuring that all modules fit comfortably without the need of force. Location of the modules on the bi-material frames is controlled

by this mechanism and it maintains uniform gaps between the modules. This mechanism uses locks which remain free from any stress after mounting, thus making the system extremely durable with long life.

Wiring connections can be made upon fixing the modules on the bi-material frames. Cover plates can be mounted after final painting of walls, thus preventing the plates from getting soiled during construction and painting work.

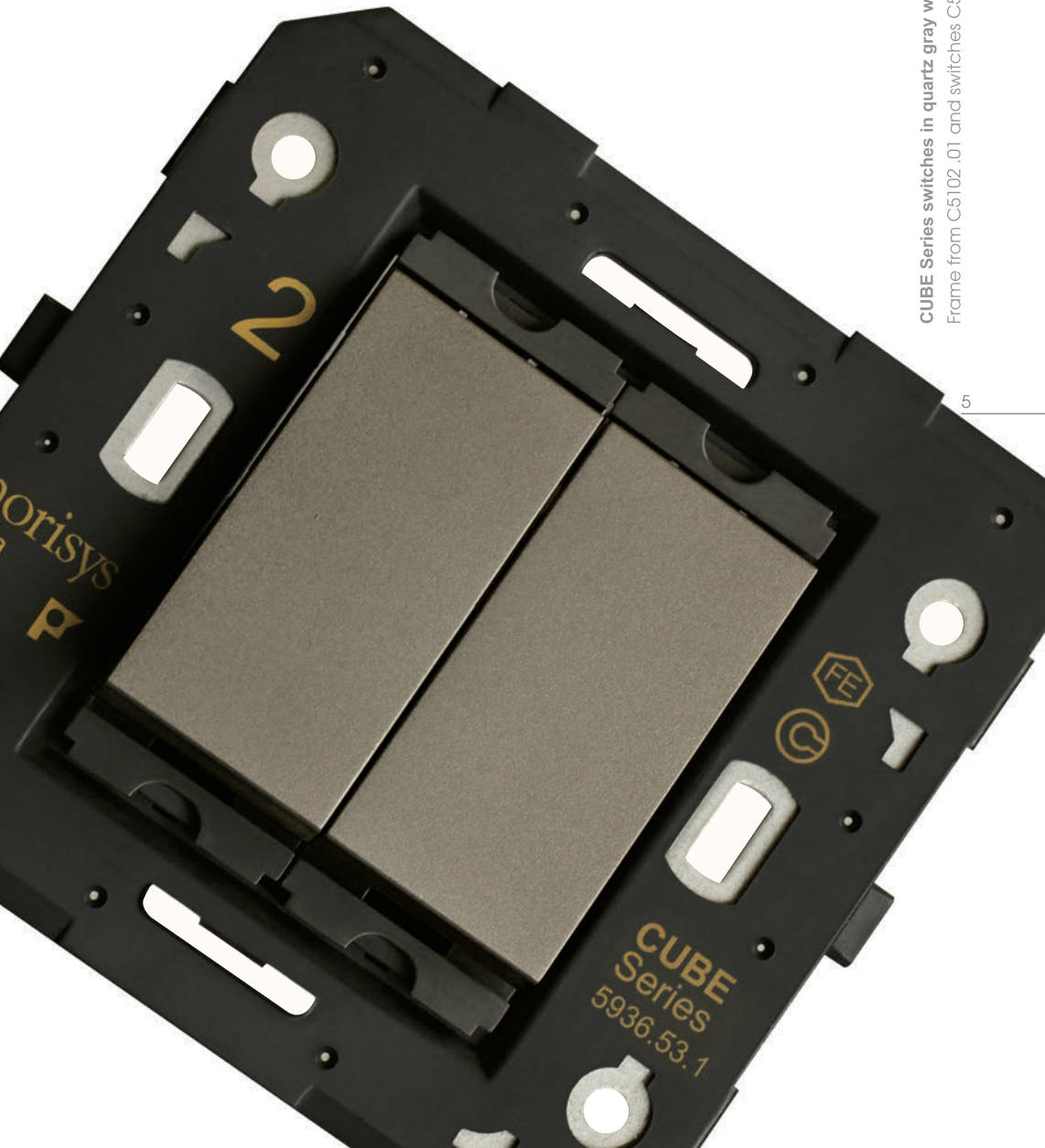

CUBE Series switches in quartz gray with a two module frame
Frame from C5102.01 and switches C5110.02

CUBE Series

CUBE Series is a modular product range which is designed to satisfy the requirements of electrical installations in modern buildings.

The range includes switches, sockets, fan regulators & dimmers, hospitality products, communication sockets, acoustic and optical signaling products, cover plates etc.

Modules such as switches, sockets etc. are made to a standard size (module) which are mounted on frames. Front plates are available in a variety of colours, materials and finish. The front plates can be changed at any time without disturbing the wiring to adapt to changes in building interiors.

Use of engineering grade thermoset materials in CUBE Series products makes the range extremely strong and sturdy with flame proof qualities. The engineering grade thermoset material used in the products has

excellent electrical insulation properties and does not catch fire. This ensures that the products are capable of handling higher operating temperatures. This engineering grade thermoset material is conventionally used in industrial applications where high degree of electrical insulation is required.

CUBE Series quartz gray switches & sockets with solid wood plate
Switches C5110 .02 Socket C5212 .02 and Plate CW304 .06

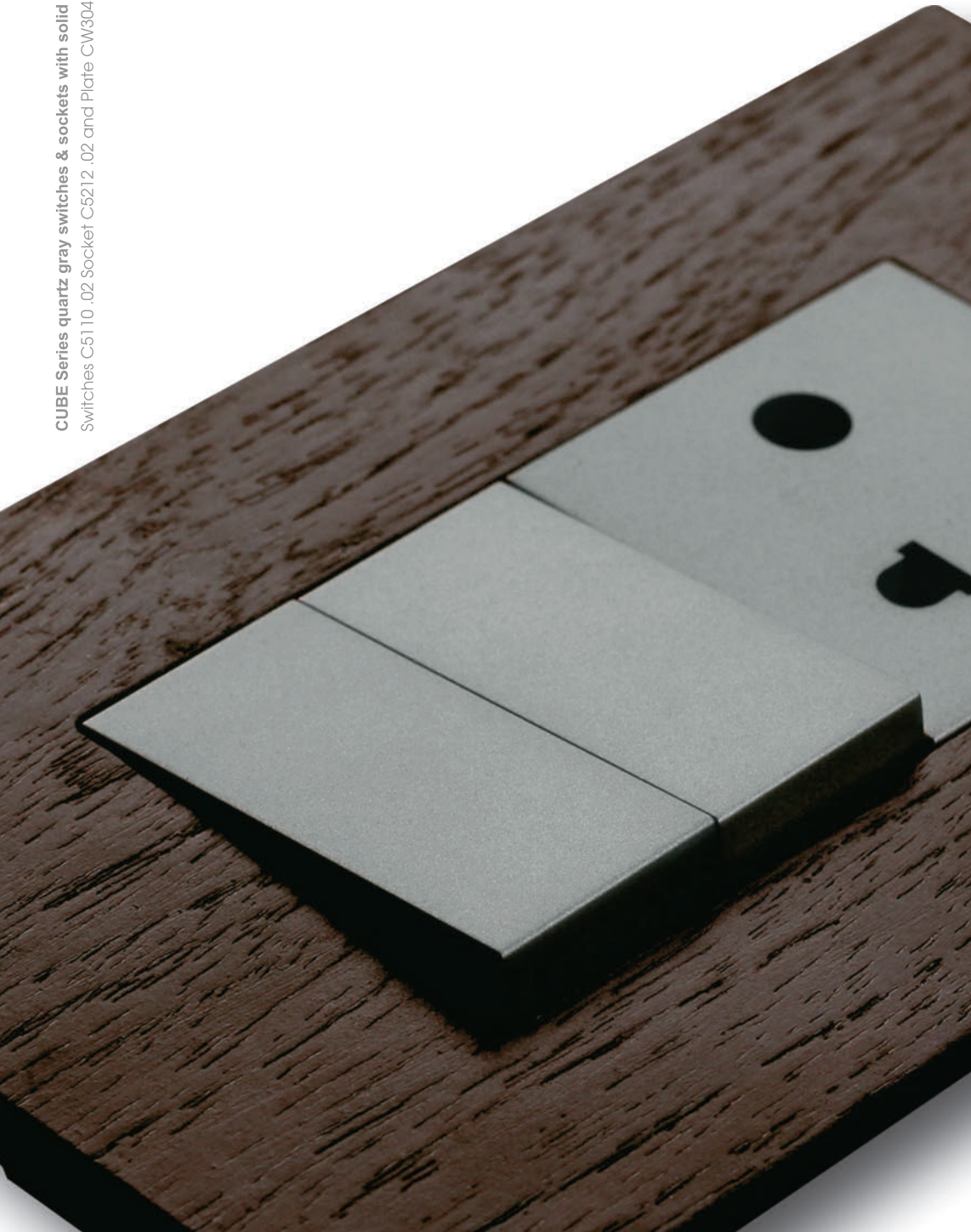

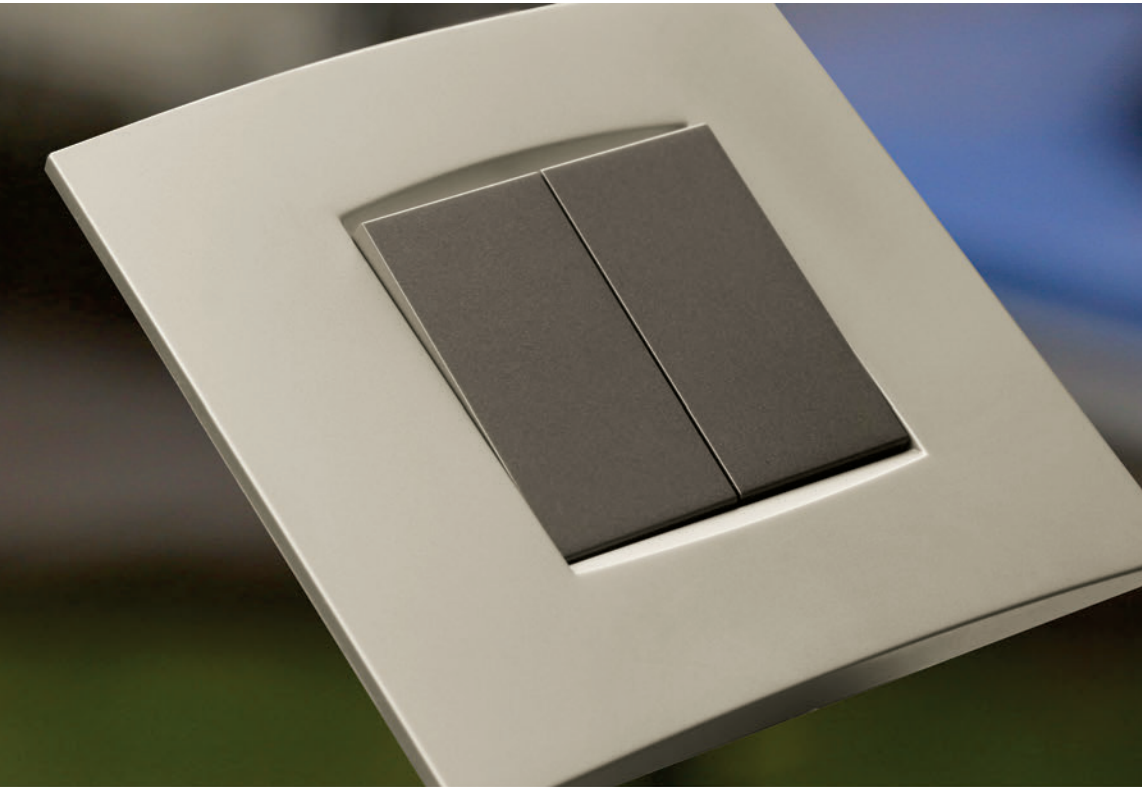

Norisy's engineers have been working day after day with diligence in order to ensure consistent electrical, mechanical and thermal qualities.

CUBE Series

the technology inside

CUBE Series switches have contacts which provide very high current carrying capacity. The contact design, snap action mechanism, appropriate contact pressure, wiping action between the contacts and use of high engineering grade materials result in minimum arcing. Reduction in arcing ensures a very long operating life for the switches.

Proper shrouding of terminals and current carrying parts is provided in all switches and sockets. Since the live parts are separated by thermoset material, they are prevented from fusing together in case of any over-heating.

LED indicators used in the CUBE Series switches emit a soft, reassuring glow which is mild and soothing to the eyes. Use of high quality LEDs ensures a long indicator life without flicker.

Norisys engineers developed a unique ring-shaped spring which solves the frequently occurring problem of burnouts in power sockets. Norisys sockets feature this ring-shaped spring which maintains a uniform pressure on the brass contact tubes. This pressure clamps the plug pins tightly leading to a firm spark-free contact, thus eliminating overheating and consequential burnouts.

CUBE Series sockets are child protected. Safety shutters have been put in place to prevent any accidental contact with live parts thereby reducing risk of electric shocks.

CUBE Series

tiny mcb - modular mcb system

Tiny MCB is a high performance and a reliable safety device, which has now become a common household product. It is a modular MCB that can be mounted simply like a switch. These MCBs are front mounted along with switches, sockets etc. of CUBE Series or SQUARE Series products. Tiny MCB can also be mounted on sunmica sheets of any existing or new receptacle commonly used in household wiring.

Single Pole and Double Pole versions are available in Tiny MCB in various ratings. Distribution Boards for single phase are made using Tiny MCBs on CUBE Series or SQUARE Series plates or even on sunmica sheets. These distribution boards are compact and smart. When mounted with a 25Ampere socket, it offers the perfect solution for switching airconditioners and geysers.

Tiny MCBs are high performance devices that incorporate advanced developments in electrical engineering technology for protection of circuits and individual appliances. They are typically used for switching and protection of air-conditioners, geysers, pumps, heaters and other appliances that draw high current in domestic applications. These MCBs are also used as a master switch in rooms to switch off the entire circuit in a room for energy saving.

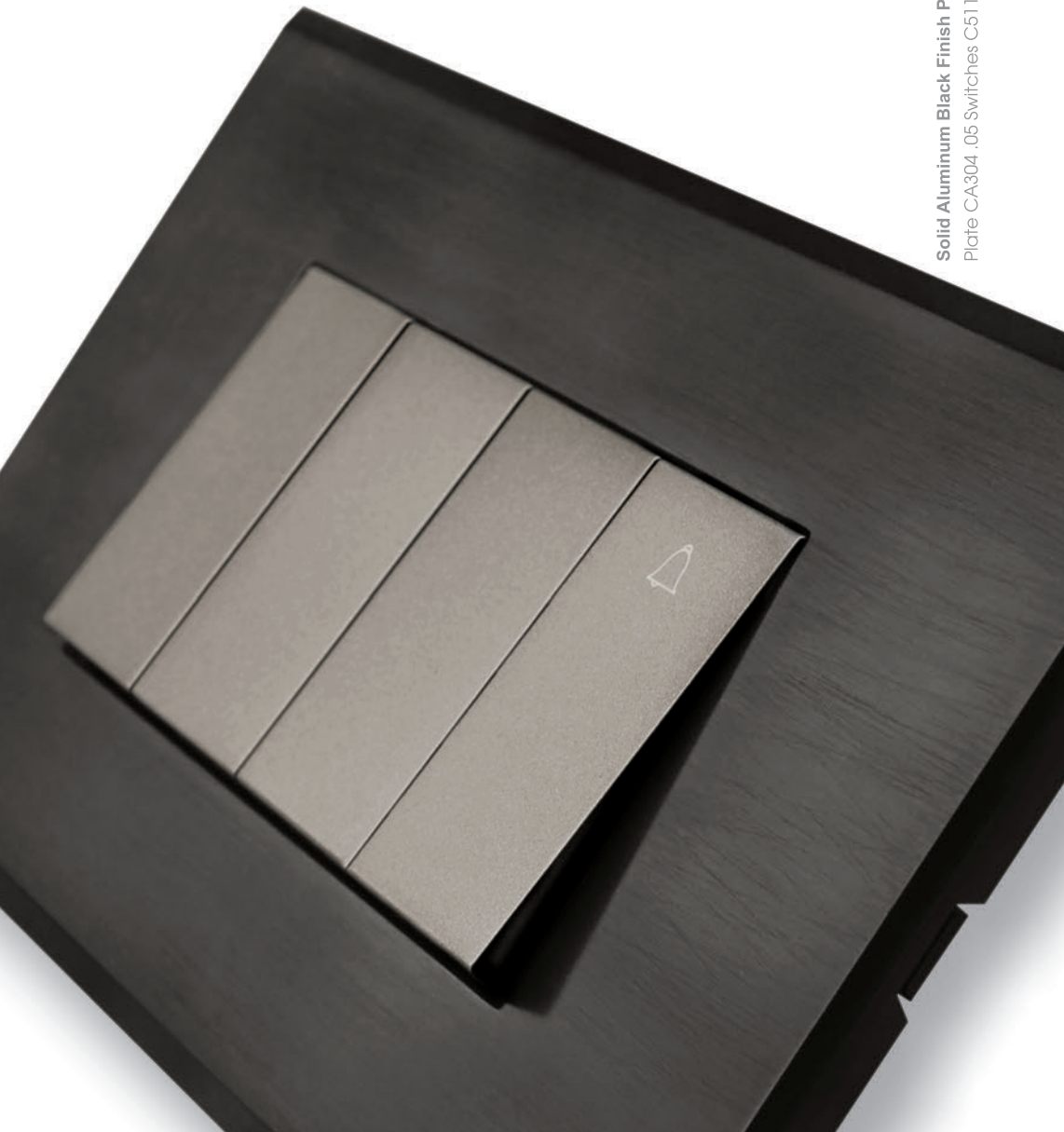

Solid Aluminum Black Finish Plate with quartz gray switches
Plate CA304 .05 Switches C5110 .02 Bell C5310 .02

CUBE Series

fan regulators & vector plates

Fan regulator in CUBE Series demonstrates the way engineers at Norisys pay attention to product details. The knob featured in this device solves the common problem of knobs coming off or falling. The dual knob design ensures that the knob cannot be pulled out, thus ensuring that the knobs remain intact even after years of usage.

The unique bar shaped knob is a visual treat and blends with modern interiors, besides being ergonomic. The bar shaped knob is easy to grip and is much more comfortable to operate than regular circular ones.

This fan regulator is a totally dependable device that eliminates failures normally experienced with electronic regulators. It has full rotation operation with no end point, thereby preventing any undue pressure from damaging the regulator. Total hum-free operation, six speeds of operation,

no radio interference and negligible power loss are other benefits of this regulator.

CUBE Series Vector Plates incorporate a redefined design capable of harmoniously blending into different living styles. These plates are available in Frost White, Quartz Grey and Ice Silver colour options. The shape of these plates is urbane and exudes aesthetic elegance. These plates are made from high gloss virgin grade UV stabilized engineering plastics.



Vector Plate in Ice Silver colour with two switches & fan regulator
Plate C5404 .03 Switches C5110 .01 Fan Regulator C5900 .01

Each piece of Solid Aluminum plate is machined out of a solid block of aluminum to give it the sharp and clean look. These plates are available in natural finish and black finish and match very well with Frost White modules and Quartz Gray modules. The complete look is a solid, well engineered smart composition.



Solid Aluminum Plate with emergency light & step marker
Plate CA304 .04 Emer Light C5715 .01 Step Marker C5721 .01

CUBE Series

special material machined plates

Norisys special material plates set the standards for stylish design combined with top quality materials: Solid Aluminum, Solid Glass, Solid Wood, Solid Marble finish. The classy design creates an exclusive flair owing to the interaction of contrasts between the severity of optical forms and surface finish.

Solid glass plates are made of engineered glass which is tempered and toughened to make it rugged and to impart a nice uniform lustre. Solid glass plates are available in Ice White and Metal Gray colours. Both the options provide a radiance to the interiors.

Solid Wood plates are crafted out of best quality natural wood, which is treated and seasoned to ensure a long life. These plates are offered in Natural Pinewood Polish and Dark Mahogany Polish. Special Protective coatings and surface hardeners make the surface wear

resistant. Wood lends a natural feel to the clean edges of engineering plastics and metals. This natural feel can be an asset for interior designers for making the electrical outlets blend with the furniture.

Solid Marble finish plates are individually machined from solid blocks so that the end product is a crisp clean cut flat plate which looks modern in aesthetics. The Sparkle White option matches very well with white marble whereas the Terra Beige option matches very well with marbles from the Beige and Brown family. Once mounted alongwith the CUBE Series modules, it merges the looks of technical accuracy with natural marble feel.

CUBE Series

CUBE Series marks the evolution of Norisys' research as it once again focuses on engineering design, especially its environmental qualities, and pivots on the concepts of variability and sustainability, performance and simplicity of use.

16

It is a new way of creating environments, made possible by the types of products that have been developed, namely by using advanced materials and engineering. The result is an installation system that seamlessly blends with the building.

As a professional of electrical switchgear, today Norisys constructs innovative switchgear systems at the highest level and has established itself by sheer experience and high quality workmanship. The two product ranges namely CUBE Series and SQUARE Series, make sure that products are available for highly specific requirements as well.

In CUBE Series switches, the spring geometry of the moving contact of the mechanism has a natural cushioning function, which significantly reduces its electrical recoil as well as wear. An increase in the quantum of silver in the contacts, helps to reconcile the safety of electric switching with smoothness of operation.



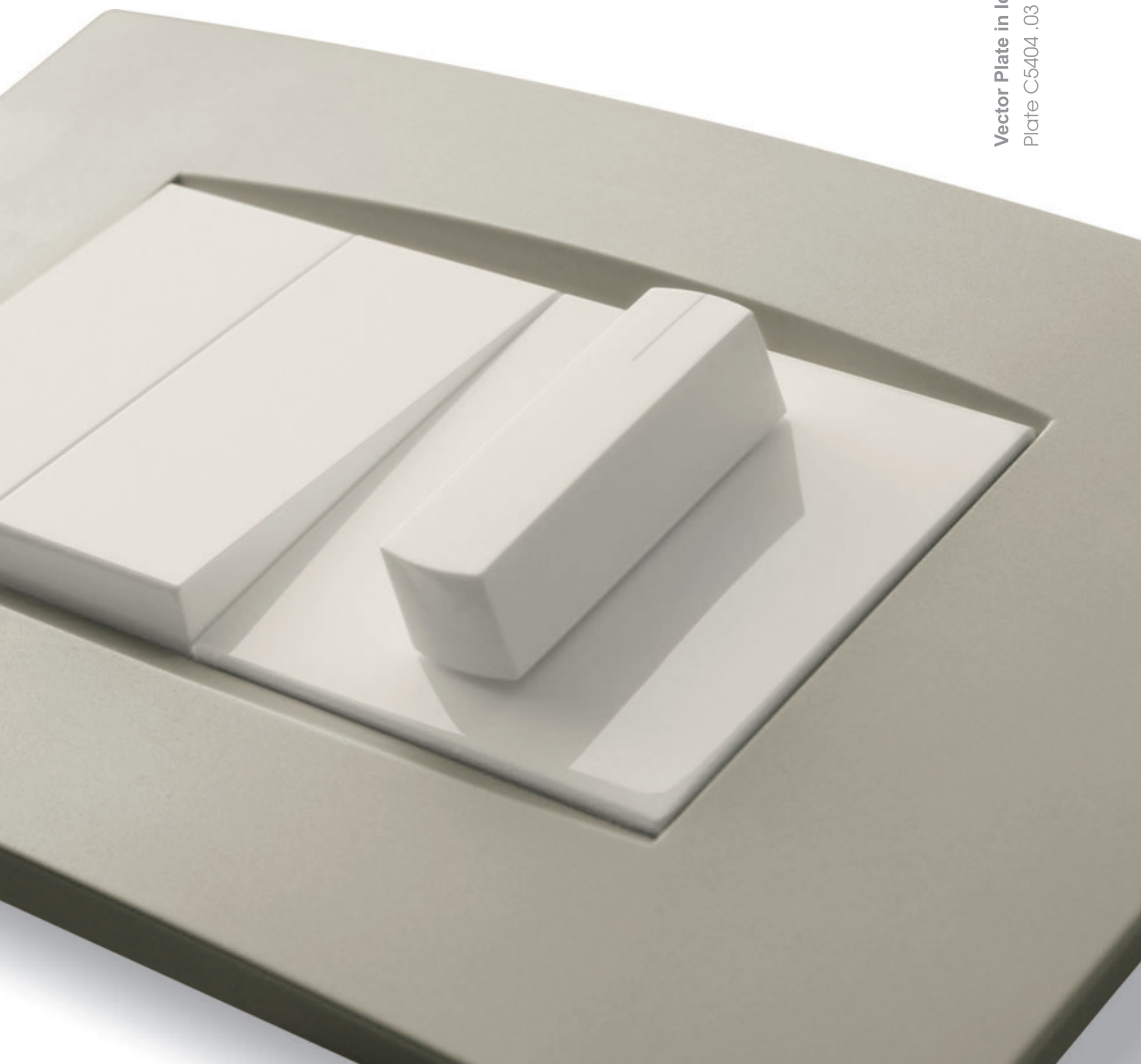

Vector Plate in Ice Silver colour with two switches & fan regulator
Plate C5404 .03 Switches C5110 .01 Fan Regulator C5900 .01

Architecture of modern hotels and hospitals makes the highest demand for design and function of electrical installations. Norisys offers high-end products suited for the hospitality industry.



CUBE Series

hotel installation systems

CUBE Series installations do not only look good, they are also ideally convenient to operate. Especially for use in hotels and hospitals where one seeks quiet and wellbeing. It is important to have fittings that stand for good feeling.

Products like Shaver Sockets, Key Card Switches, Call bell system with register, Buzzers, Speakers for Music circuits, Step Marker Night Light, Do Not Disturb and Clean My Room dedicated switches, Bell Switch with DND & Clean My Room connections provide the necessary convenience for guests in hotels.

Smart Plates in CUBE Series have a distinct classic design offering comfort to the eye. The plates merge with the interiors very well creating a homogeneous look. Inner bi-material frames give adequate support to the plates keeping all the modules securely in place without yielding to pressure from the wires inside or during insertion / removal of plug tops.

Good quality data sockets are a prerequisite at all workplaces because of increasing speeds in data transmission. Norisys communication sockets are available for all types of telephone and data connections. Shutters for dust protection is provided in all data sockets along with a circuit marking label with a clear cover. The marking can give clear indication on the data line connected to the socket. Communication sockets are available for Cat 5, Cat 6, RJ-11 lines.

CUBE Series single phase motor starters

Single Phase Motor Starters - a safety device designed by Norisys engineers with advanced current handling. It is a device for switching and protection of appliances such as room air-conditioners, refrigerators, washing machines, computers, water coolers, pumps etc. up to 25Amperes. In case of overload, the Single Phase Motor Starter trips, thereby protecting the appliance from burn-out.

These starters are normally mounted with sockets from CUBE Series or SQUARE Series. This combination forms an efficient module for single phase applications. The unit is compact and economical and is operated by the push of buttons located in the front of the Starter.

Installation of Single Phase Motor Starters is very simple as they can be installed simply like a switch. They can also be mounted on Surface Mount Boxes from Norisys for an elegant stylized look.

The unique feature of Single Phase Motor Starters is the facility of current setting. The starter tripping can be precisely set as per the requirement of the individual appliance. This setting can be done simply by the turn of a screw provided on the front panel of the starter. After setting the starter tripping current, the device protects the appliance from overloads with desired precision.

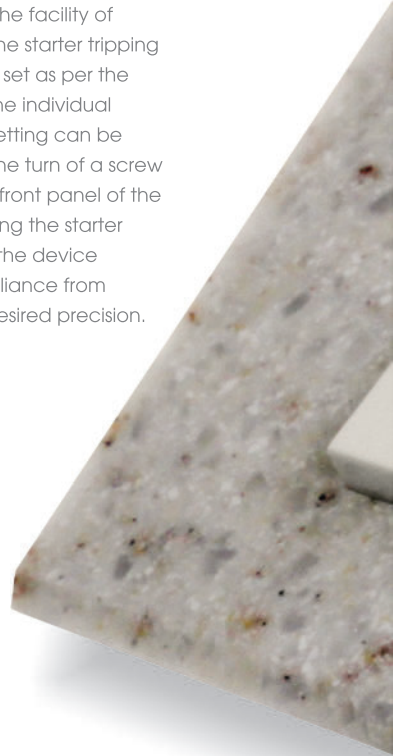



Solid Marble Finish Plate Terra Beige with switches in Frost White
Plate CM304.11 Switches C5110.01 & Fan Regulator C5900.01

SQUARE Series

SQUARE Series products is a design which has evolved over a period of time. Functional qualities and the mounting system is proven and the technology tested. Classic looks of this range makes it a timeless design.

22

Unique feature of this Series is the mounting system. All modules are mounted on frames using screws. This makes the assembly very sturdy. The modules which are mounted by screws can withstand tremendous amount of pressure. Back housing of sockets rest on the frame and provides a firm support - required in case of excessive push pressure while inserting plugs.

SQUARE Series products retain the special features offered by the company in the past, yet have been redesigned for modernity. Use of thermoset material for the core areas makes the switches and sockets highly durable and capable of handling higher currents.

UV stabilized virgin grade polycarbonate material is used in SQUARE Series to impart a highly polished glossy surface. Locators in the modules and frames facilitate accuracy in mounting ensuring uniform gaps between the modules. Spring loaded tubes in sockets ensure a firm contact with plug pins for smooth operation.



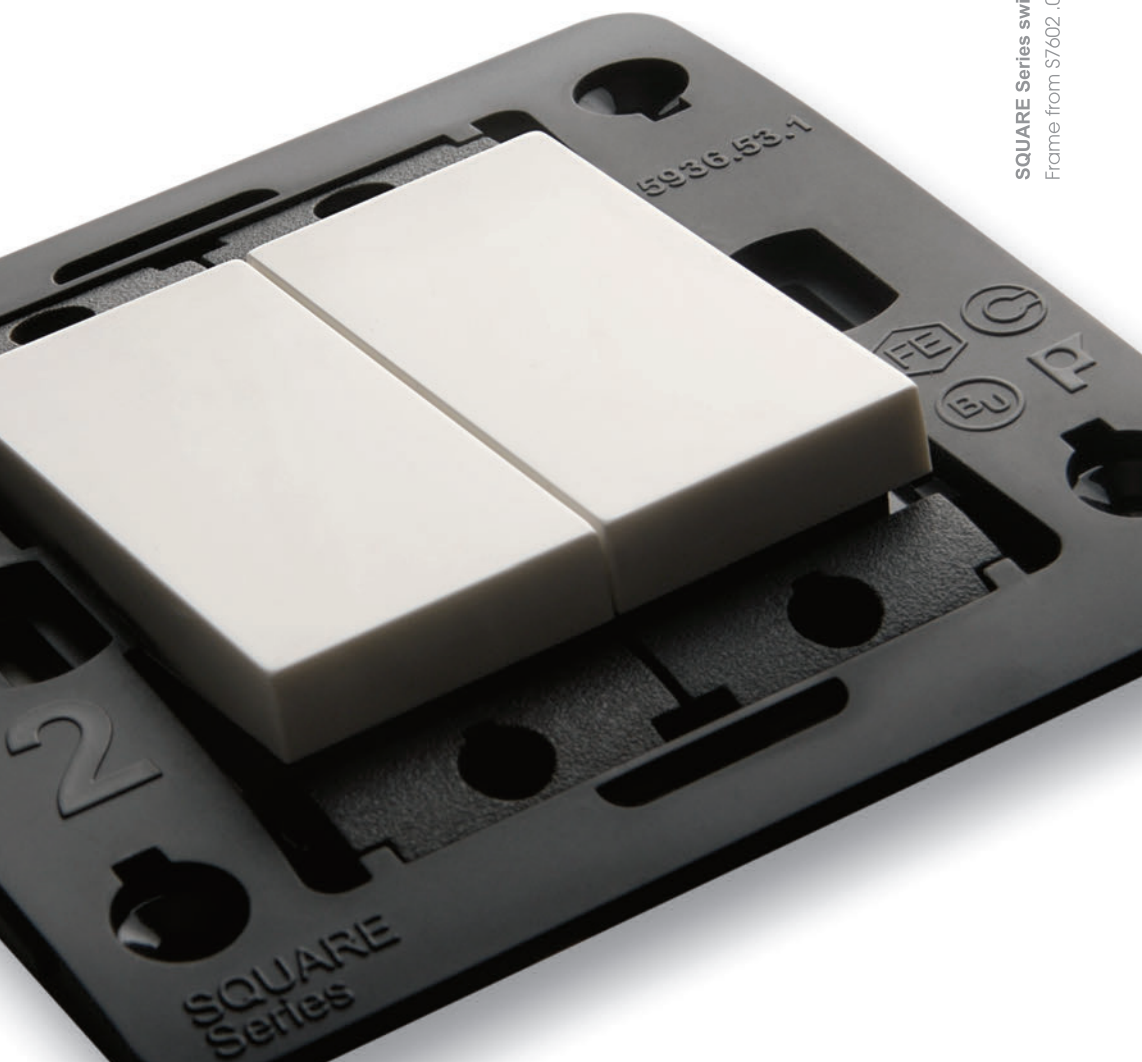

SQUARE Series switches in frost white with a two module frame
Frame from S7602 .01 and switches S7110 .01



C5110 .01
C5130 .01
C5730 .01



C5210 .01
C5230 .01



C5310 .01



C5441 .01



C5340 .01

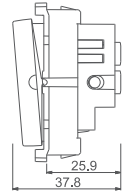

C5111 .01
C5131 .01
C5731 .01



C5211 .01
C5231 .01



C5311 .01



C5431 .01



C5341 .01

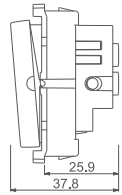

24



C5140 .01
C5160 .01

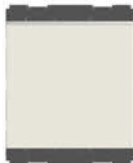

C5180 .01

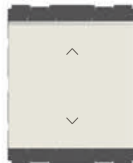

C5240 .01
C5260 .01

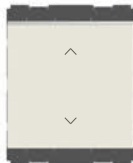

C5280 .01

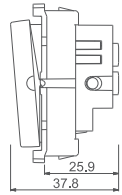

C5141 .01
C5161 .01

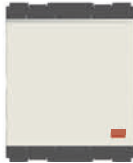

C5191 .01
C5171 .01



C5241 .01
C5261 .01



C5281 .01
C5291 .01

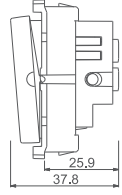

CUBE Series

Switches Frost White

Cat no.	Description	Price (Rs.)
C5110 .01	Switch 6A One-way - 1 Module	158.00
C5111 .01	Switch 6A One-way with indicator - 1 Module	254.00
C5210 .01	Switch 6A Two-way - 1 Module	228.00
C5211 .01	Switch 6A Two-way with indicator - 1 Module	351.00
C5130 .01	Switch 16A One-way - 1 Module	271.00
C5131 .01	Switch 16A One-way with indicator - 1 Module	342.00
C5230 .01	Switch 16A Two-way - 1 Module	281.00
C5231 .01	Switch 16A Two-way with indicator - 1 Module	364.00
C5730 .01	Switch 25A One-way - 1 Module	379.00
C5731 .01	Switch 25A One-way with indicator - 1 Module	446.00
C5310 .01	Switch 6A - Bell - 1 Module	235.00
C5311 .01	Switch 6A - Bell with indicator - 1 Module	324.00
C5140 .01	Palm Switch 6A One-way Single Pole - 2 Module	211.00
C5141 .01	Palm Switch 6A One-way Single Pole with indicator - 2 Module	273.00
C5240 .01	Palm Switch 6A Two-way Single Pole - 2 Module	245.00
C5241 .01	Palm Switch 6A Two-way Single Pole with indicator - 2 Module	346.00
C5160 .01	Palm Switch 16A One-way Single Pole - 2 Module	284.00
C5161 .01	Palm Switch 16A One-way Single Pole with indicator - 2 Module	346.00
C5260 .01	Palm Switch 16A Two-way Single Pole - 2 Module	311.00
C5261 .01	Palm Switch 16A Two-way Single Pole with indicator - 2 Module	405.00
C5180 .01	Palm Switch 6A One-way Double Pole - 2 Module	397.00
C5280 .01	Palm Switch 6A Two-way Double Pole - 2 Module	422.00
C5281 .01	Palm Switch 6A Two-way Double Pole with indicator - 2 Module	470.00
C5191 .01	Palm Switch 16A One-way Double Pole with indicator - 2 Module	552.00
C5291 .01	Palm Switch 16A Two-way Double Pole with indicator - 2 Module	657.00
C5171 .01	Palm Switch 25A One-way Double Pole with indicator - 2 Module	660.00
C5340 .01	Palm Bell Switch Single Pole - 2 Module	292.00
C5341 .01	Palm Bell Switch Single Pole with indicator - 2 Module	377.00
C5441 .01	Switch 16A One-way with 'Geyser' Symbol with indicator - 1 Module	362.00
C5431 .01	Switch 6A One-way with 'Fan' or 'Light' or 'Exhaust' symbol - 1 Module	273.00



C2110.01



C2111.01



C2010.01



C2011.01



C2130.01



C2131.01



C2030.01



C2031.01



C2140.01



C2141.01



C2040.01



C2041.01



CUBE Series

Twin Switches Frost White

Cat no.	Description	Price (Rs.)
C2110 .01	Twin Switch 6A - 2 Gang - Both switches 1 way - 1 Module	498.00
C2111 .01	Twin Switch 6A - 2 Gang - Both switches 1 way with indicator - 1 Module	730.00
C2010 .01	Twin Switch 6A - 1 Gang - 2 way + Dummy - 1 Module	553.00
C2011 .01	Twin Switch 6A - 1 Gang - 2 way with indicator + Dummy - 1 Module	771.00
C2130 .01	Twin Switch 16A - 2 Gang - Both switches 1 way - 1 Module	797.00
C2131 .01	Twin Switch 16A - 2 Gang - Both switches 1 way with indicator-1Module	1002.00
C2030 .01	Twin Switch 16A - 1 Gang - 2 way + Dummy - 1 Module	755.00
C2031 .01	Twin Switch 16A - 1 Gang - 2 way with indicator + Dummy - 1 Module	968.00
C2140 .01	Twin Switch 6A - 2 Gang - Both Switches Bell - 1 Module	756.00
C2141 .01	Twin Switch 6A - 2 Gang - Both Switches Bell with Indicator - 1 Module	998.00
C2040 .01	Twin Switch 6A - 1 Gang - 1 Bell + 1 Dummy - 1 Module	609.00
C2041 .01	Twin Switch 6A - 1 Gang - 1 Bell with Indicator + 1 Dummy - 1 Module	797.00



C5213 .01



C5331 .01



C5332 .01

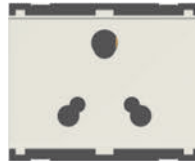

C5552 .01

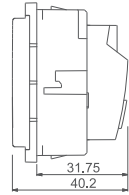

C5212 .01



C5532 .01

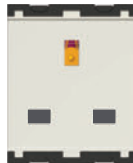

C5531 .01

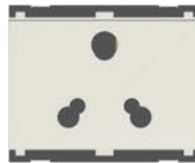

C5752 .01

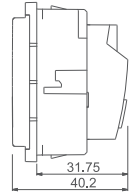

C5010 .01

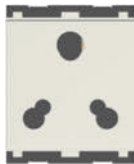

C5732 .01



C5733 .01



C5902 .01
C5903 .01
C5909 .01

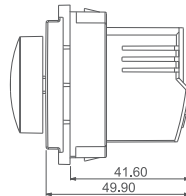

C5904 .01



C5905 .01
C5908 .01



C5900 .01
C5910 .01
C5912 .01



C5901 .01
C5911 .01



C5913 .01

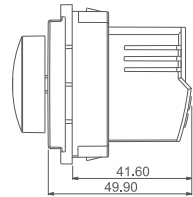

CUBE Series

Sockets Frost White

Cat no.	Description	Price (Rs.)
C5213 .01	Socket 6A 3-Pin-only Shuttered - 2 Module (As per Indian Standard)	307.00
C5332 .01	Socket 16A and 6A 3-Pin Shuttered - 2 Module (As per Indian Standard)	430.00
C5552 .01	Socket 16A and 6A 3-Pin Shuttered - 3 Module (As per Indian Standard)	493.00
C5331 .01	Socket 16A 3-Pin-only Shuttered - 2 Module (As per Indian Standard)	402.00
C5212 .01	Socket 6A 3+2 Pin [Round & Flat] Shuttered - 2 Module *	347.00
C5010 .01	Socket 6A 2 Pin [Round & Flat] - 1 Module *	235.00
C5532 .01	Socket 13A International Multi socket Shuttered - 2 Module *	430.00
C5531 .01	Socket 13A 3-Pin Flat-only Socket Shuttered - 2 Module *	406.00
C5732 .01	Socket 25A and 6A 3-Pin Shuttered - 2 Module *	490.00
C5752 .01	Socket 25A and 6A 3-Pin Shuttered - 3 Module *	577.00
C5733 .01	Socket 25A 3-Pin-only Shuttered - 2 Module *	462.00

29

Fan Regulators & Dimmers Frost White

C5900 .01	Fan Regulator for 80W fan - Step Type with Bar Knob - 2 Module	1076.00
C5901 .01	Fan Regulator for 80W fan - Step Type with Round Knob - 2 Module	1032.00
C5910 .01	Fan Regulator for 120W fan - Step Type with Bar Knob - 2 Module	1183.00
C5911 .01	Fan Regulator for 120W fan - Step Type with Round Knob - 2 Module	1141.00
C5912 .01	Fan Regulator for 120W fan - 8-Step Type with Bar Knob - 2 Module	1208.00
C5913 .01	Fan Regulator for 120W fan - 8-Step Type with Round Knob - 2 Module	1164.00
C5902 .01	Dimmer 500 Watts - 2 Module	865.00
C5903 .01	Dimmer 1000 Watts - 2 Module	1211.00
C5904 .01	Fan Regulator Single Module for 80W Fan - Step Type - 1 Module	708.00
C5905 .01	Dimmer 500 Watts - 1 Module	667.00
C5908 .01	Dimmer for LED Lights 100W (3 wire system) - 1 Module	663.00
C5909 .01	Dimmer for LED Lights Digital Choke 100W (4 wire system) - 2 Module	865.00

* Only for export outside India



C5707 .01
C5708 .01



C5703 .01
C5704 .01
C5705 .01
C5505 .01



C5715 .01
C5716 .01



C5727 .01



C5706 .01
C5709 .01



C5721 .01



C5710 .01

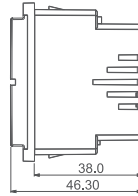

CUBE Series

Acoustic & Optical Signaling Frost White

Cat no.	Description	Price (Rs.)
C5707 .01	Electronic Bell - 2 Module	675.00
C5727 .01	Indicator Light - 1 Module	307.00
C5703 .01	Prismatic Overdoor Bulkhead Indicator - White - 2 Module	615.00
C5704 .01	Prismatic Overdoor Bulkhead Indicator - Green - 2 Module	635.00
C5705 .01	Prismatic Overdoor Bulkhead Indicator - Red - 2 Module	635.00
C5505 .01	Prismatic Overdoor Bulkhead Indicator - Resettable - 2 Module	960.00
C5715 .01	Emergency Light - 2 Module	1642.00
C5706 .01	Speaker for audio music circuit - 2 Module	1194.00
C5716 .01	Night Light with switch and dimming option - 2 Module	1042.00
C5721 .01	Step Marker Lamp/ Night Lamp - 2 Module	688.00
C5709 .01	Electronic Buzzer - 2 Module	611.00
C5710 .01	Electronic Buzzer - 1 Module	542.00
C5708 .01	Ultrasonic Mosquito Repellent - 2 Module	966.00



C5712 .01



C5460 .01



C5711 .01



C5262 .01
C5263 .01

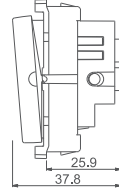

C5450 .01



C5906 .01



C5233 .01



C5232 .01

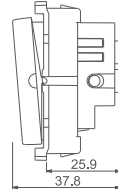

C5718 .01

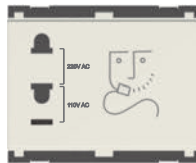

C5723 .01



C5719 .01

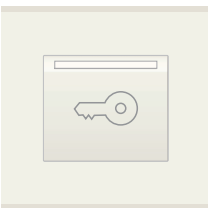
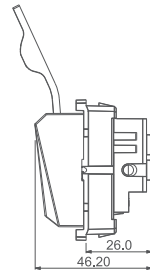

C5717 .01

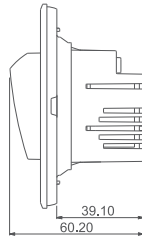

CUBE Series

Hospitality Modules Frost White

Cat no.	Description	Price (Rs.)
C5717 .01	25A Smart Card operated Electronic switch in 2 Module with indicator & exit time delay feature including Smart Card - 2 Module	3070.00
C5718 .01	30A Smart Card operated Electronic switch in 3 Module with indicator & exit time delay feature including Smart Card - 3 Module	2948.00
C5724 .01	Smart Card - Customized	222.00
C5719 .01	25A Key Fob Switch Double Pole with indicator - 2 Module	1436.00
C5720 .01	Key Fob - Customized	227.00
C5723 .01	Shaver Socket 220V/110V - 3 Module	2799.00
C5711 .01	Call Bell Station with Register and provision for External Buzzer - 2M	1587.00
C5712 .01	External Buzzer for Call Bell Station - 2 Module	566.00
C5232 .01	"Do Not Disturb" Switch with indicator - 1 Module	456.00
C5233 .01	"Clean My Room" Switch with indicator - 1 Module	456.00
C5906 .01	Volume Control 100 Ohms 1 Watt - 2 Module	758.00
C5262 .01	Bell Switch with "Do Not Disturb" & "Clean My Room" Indicator - 2M	738.00
C5263 .01	Bell Switch with "DND", "CMR" & Guest is in Indicator - 2M	817.00
C5450 .01	Push Button station (Start - Stop) - 2 Module	636.00
C5460 .01	Curtain Control Switch 6A - 2 Module	704.00



C5729 .01



C5739 .01



C5800 .01
C5809 .01

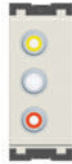

C5701 .01



C5700 .01



C5802 .01
C5803 .01

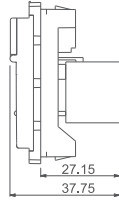

C5725 .01
C5736 .01



C5836 .01
C5837 .01



C5797 .01



C5500 .01



C5798 .01



C5820 .01

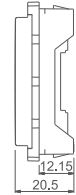

C5936 .01
C5938 .01



C5939 .01

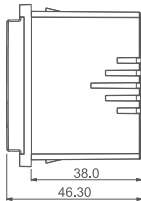

P5131 .01



P5151 .01



P5111 .01

CUBE Series

Communiqué & Support Modules Frost White

Cat no.	Description	Price (Rs.)
C5797 .01	Coaxial T.V Socket - 1 Module	244.00
C5725 .01	USB Extension Socket - 1 Module	580.00
C5736 .01	USB Charger Socket Outlet A Type - 2.1 Amps - 1 Module	2599.00
C5836 .01	USB Charger Socket Outlet C Type - 2.1 Amps - 1 Module	2875.00
C5936 .01	USB Charger Socket Outlet A+C Type - 2.1 Amps - 1 Module	3136.00
C5837 .01	USB Charger Socket Outlet C Type - 3.1 Amps - 1 Module	3125.00
C5938 .01	USB Charger Socket Outlet A+C Type - 3.1 Amps - 1 Module	3353.00
C5939 .01	USB Charger Socket Outlet C+C Type - 3.1 Amps - 1 Module	3517.00
C5729 .01	Computer Monitor Output Socket - 1 Module	403.00
C5739 .01	HDMI Socket - 1 Module	1579.00
C5800 .01	Telephone Socket RJ-11 Double Line Shuttered - 1 Module	234.00
C5820 .01	Twin Telephone Socket RJ-11 - 1 Module	378.00
C5802 .01	Information Socket 6e - UTP Shuttered - 1 Module	863.00
C5803 .01	Information Socket 6a - UTP Shuttered - 1 Module	1456.00
C5701 .01	Triple RCA Audio Visual Socket - 1 Module	799.00
C5500 .01	Cord Outlet - 1 Module	178.00
C5700 .01	Blanking Plate - 1 Module	61.00
C5798 .01	Audio Port / Jack 3.5mm - 1 Module	463.00
C5809 .01	Fitment for RJ-45 Computer Socket Shuttered - 1 Module	261.00

35

Plugs Transparent with Dark Gray

P5111 .01	Plug Top 6A with LED indicator	163.00
P5131 .01	Plug Top 16A with LED indicator	237.00
P5151 .01	Plug Top 25A with LED indicator	295.00



V5110 .01
V5210 .01
V5130 .01
V5230 .01



V5111 .01
V5211 .01
V5131 .01
V5231 .01



V5140 .01
V5240 .01
V5160 .01
V5180 .01



V5141 .01
V5241 .01
V5161 .01
V5261 .01



V5281 .01
V5191 .01
V5291 .01
V5171 .01



V5340 .01
V5341 .01

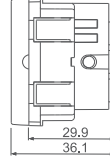

V5901 .01
V5911 .01



V5913 .01

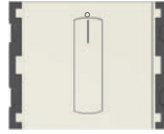

V5900 .01
V5910 .01
V5912 .01

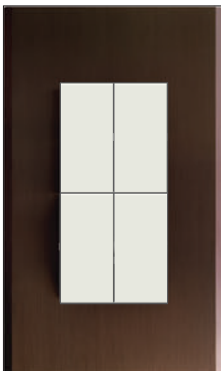
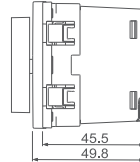

Vertical Switches and Vertical Fan Regulators can be mounted on all types of standard Cube Series Plates. Metal Boxes, Frames and Plates need to be fixed in the vertical position as shown here.

CUBE Series

Vertical Switches Frost White

Cat no.	Description	Price (Rs.)
V5110 .01	Vertical Switches - 2 Gang - Both switches 6A 1 way - 2 Module	390.00
V5111 .01	Vertical Switches - 2 Gang - Both switches 6A 1 way with indicator - 2M	515.00
V5210 .01	Vertical Switches - 2 Gang - Both switches 6A 2 way - 2 Module	472.00
V5211 .01	Vertical Switches - 2 Gang - Both switches 6A 2 way with indicator - 2M	684.00
V5130 .01	Vertical Switches - 2 Gang - Both switches 16A 1 way - 2 Module	558.00
V5131 .01	Vertical Switches - 2 Gang - Both switches 16A 1 way with indicator - 2M	705.00
V5230 .01	Vertical Switches - 2 Gang - Both switches 16A 2 way - 2 Module	590.00
V5231 .01	Vertical Switches - 2 Gang - Both switches 16A 2 way with indicator - 2M	769.00
V5140 .01	Vertical Palm Switch 6A 1 way Single Pole - 2 Module	216.00
V5141 .01	Vertical Palm Switch 6A 1 way Single Pole with indicator - 2 Module	276.00
V5240 .01	Vertical Palm Switch 6A 2 way Single Pole - 2 Module	245.00
V5241 .01	Vertical Palm Switch 6A 2 way Single Pole with indicator - 2 Module	349.00
V5160 .01	Vertical Palm Switch 16A 1 way Single Pole - 2 Module	286.00
V5161 .01	Vertical Palm Switch 16A 1 way Single Pole with indicator - 2 Module	349.00
V5261 .01	Vertical Palm Switch 16A 2 way Single Pole with indicator - 2 Module	407.00
V5180 .01	Vertical Palm Switch 6A 1 way Double Pole - 2 Module	397.00
V5281 .01	Vertical Palm Switch 6A 2 way Double Pole with indicator - 2 Module	474.00
V5191 .01	Vertical Palm Switch 16A 1 way Double Pole with indicator - 2 Module	558.00
V5291 .01	Vertical Palm Switch 16A 2 way Double Pole with indicator - 2 Module	664.00
V5171 .01	Vertical Palm Switch 25A 1 way Double Pole with indicator - 2 Module	667.00
V5340 .01	Vertical Palm Bell Switch Single Pole - 2 Module	292.00
V5341 .01	Vertical Palm Bell Switch Single Pole with indicator - 2 Module	382.00

37

Vertical Fan Regulators & Dimmers Frost White

V5900 .01	Vertical Fan Regulator for 80W fan - Step Type with Bar Knob - 2M	1076.00
V5901 .01	Vertical Fan Regulator for 80W fan - Step Type with Round Knob - 2M	1031.00
V5910 .01	Vertical Fan Regulator for 120W fan - Step Type with Bar Knob - 2M	1183.00
V5911 .01	Vertical Fan Regulator for 120W fan - Step Type with Round Knob - 2M	1140.00
V5912 .01	Vertical Fan Regulator for 120W fan - 8-Step Type with Bar Knob - 2M	1208.00
V5913 .01	Vertical Fan Regulator for 120W fan - 8-Step Type with Round Knob-2M	1164.00
V5902 .01	Vertical Dimmer 500 Watts - 2 Module	864.00



C5110 .02
C5130 .02
C5730 .02



C5210 .02
C5230 .02



C5310 .02



C5441 .02

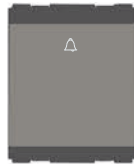

C5340 .02

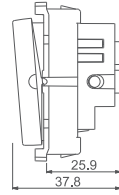

C5111 .02
C5131 .02
C5731 .02



C5211 .02
C5231 .02



C5311 .02



C5431 .02



C5341 .02

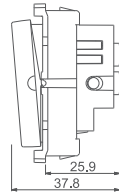

C5140 .02
C5160 .02



C5180 .02

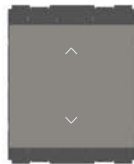

C5240 .02
C5260 .02



C5280 .02

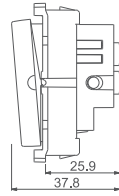

C5141 .02
C5161 .02



C5191 .02
C5171 .02



C5241 .02
C5261 .02



C5281 .02
C5291 .02

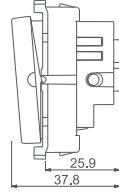

CUBE Series

Switches Quartz Gray

Cat no.	Description	Price (Rs.)
C5110 .02	Switch 6A One-way - 1 Module	196.00
C5111 .02	Switch 6A One-way with indicator - 1 Module	324.00
C5210 .02	Switch 6A Two-way - 1 Module	290.00
C5211 .02	Switch 6A Two-way with indicator - 1 Module	435.00
C5130 .02	Switch 16A One-way - 1 Module	342.00
C5131 .02	Switch 16A One-way with indicator - 1 Module	435.00
C5230 .02	Switch 16A Two-way - 1 Module	356.00
C5231 .02	Switch 16A Two-way with indicator - 1 Module	462.00
C5730 .02	Switch 25A One-way - 1 Module	481.00
C5731 .02	Switch 25A One-way with indicator - 1 Module	556.00
C5310 .02	Switch 6A - Bell - 1 Module	293.00
C5311 .02	Switch 6A - Bell with indicator - 1 Module	411.00
C5140 .02	Palm Switch 6A One-way Single Pole - 2 Module	261.00
C5141 .02	Palm Switch 6A One-way Single Pole with indicator - 2 Module	341.00
C5240 .02	Palm Switch 6A Two-way Single Pole - 2 Module	303.00
C5241 .02	Palm Switch 6A Two-way Single Pole with indicator - 2 Module	430.00
C5160 .02	Palm Switch 16A One-way Single Pole - 2 Module	354.00
C5161 .02	Palm Switch 16A One-way Single Pole with indicator - 2 Module	430.00
C5260 .02	Palm Switch 16A Two-way Single Pole - 2 Module	386.00
C5261 .02	Palm Switch 16A Two-way Single Pole with indicator - 2 Module	504.00
C5180 .02	Palm Switch 6A One-way Double Pole - 2 Module	493.00
C5280 .02	Palm Switch 6A Two-way Double Pole - 2 Module	525.00
C5281 .02	Palm Switch 6A Two-way Double Pole with indicator - 2 Module	583.00
C5191 .02	Palm Switch 16A One-way Double Pole with indicator - 2 Module	687.00
C5291 .02	Palm Switch 16A Two-way Double Pole with indicator - 2 Module	818.00
C5171 .02	Palm Switch 25A One-way Double Pole with indicator - 2 Module	821.00
C5340 .02	Palm Bell Switch Single Pole - 2 Module	364.00
C5341 .02	Palm Bell Switch Single Pole with indicator - 2 Module	467.00
C5441 .02	Switch 16A One-way with 'Geyser' Symbol with indicator - 1 Module	449.00
C5431 .02	Switch 6A One-way with 'Fan' or 'Light' or 'Exhaust' symbol - 1 Module	341.00



C2110.02



C2111.02



C2010.02



C2011.02



C2130.02



C2131.02



C2030.02



C2031.02



C2140.02



C2141.02



C2040.02



C2041.02



CUBE Series

Twin Switches Quartz Gray

Cat no.	Description	Price (Rs.)
C2110 .02	Twin Switch 6A - 2 Gang - Both switches 1 way - 1 Module	614.00
C2111 .02	Twin Switch 6A - 2 Gang - Both switches 1 way with indicator - 1 Module	954.00
C2010 .02	Twin Switch 6A - 1 Gang - 2 way + Dummy - 1 Module	711.00
C2011 .02	Twin Switch 6A - 1 Gang - 2 way with indicator + Dummy - 1 Module	993.00
C2130 .02	Twin Switch 16A - 2 Gang - Both switches 1 way - 1 Module	1029.00
C2131 .02	Twin Switch 16A - 2 Gang - Both switches 1 way with indicator-1 Module	1284.00
C2030 .02	Twin Switch 16A - 1 Gang - 2 way + Dummy - 1 Module	972.00
C2031 .02	Twin Switch 16A - 1 Gang - 2 way with indicator + Dummy - 1 Module	1248.00
C2140 .02	Twin Switch 6A - 2 Gang - Both Switches Bell - 1 Module	967.00
C2141 .02	Twin Switch 6A - 2 Gang - Both Switches Bell with Indicator - 1 Module	1278.00
C2040 .02	Twin Switch 6A - 1 Gang - 1 Bell + 1 Dummy - 1 Module	779.00
C2041 .02	Twin Switch 6A - 1 Gang - 1 Bell with Indicator + 1 Dummy - 1 Module	1020.00



C5213 .02



C5331 .02



C5332 .02

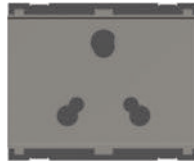

C5552 .02

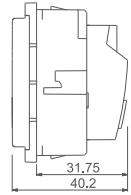

C5212 .02



C5532 .02



C5531 .02



C5752 .02

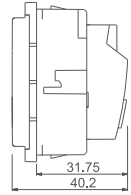

C5010 .02



C5732 .02



C5733 .02



C5902 .02
C5903 .02
C5909 .02

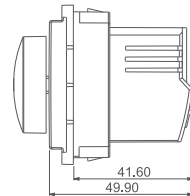

C5904 .02



C5905 .02
C5908 .02



C5900 .02
C5910 .02
C5912 .02



C5901 .02
C5911 .02



C5913 .02

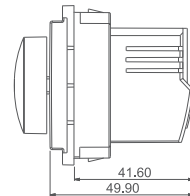

CUBE Series

Sockets Quartz Gray

Cat no.	Description	Price (Rs.)
C5213 .02	Socket 6A 3-Pin-only Shuttered - 2 Module (As per Indian Standard)	379.00
C5332 .02	Socket 16A and 6A 3-Pin Shuttered - 2 Module (As per Indian Standard)	524.00
C5552 .02	Socket 16A and 6A 3-Pin Shuttered - 3 Module (As per Indian Standard)	602.00
C5331 .02	Socket 16A 3-Pin-only Shuttered - 2 Module (As per Indian Standard)	491.00
C5212 .02	Socket 6A 3+2 Pin [Round & Flat] Shuttered - 2 Module *	427.00
C5010 .02	Socket 6A 2 Pin [Round & Flat] - 1 Module *	286.00
C5532 .02	Socket 13A International Multi socket Shuttered - 2 Module *	524.00
C5531 .02	Socket 13A 3-Pin Flat-only Socket Shuttered - 2 Module *	498.00
C5732 .02	Socket 25A and 6A 3-Pin Shuttered - 2 Module *	598.00
C5752 .02	Socket 25A and 6A 3-Pin Shuttered - 3 Module *	706.00
C5733 .02	Socket 25A 3-Pin-only Shuttered - 2 Module *	566.00

Fan Regulators & Dimmers Quartz Gray

C5900 .02	Fan Regulator for 80W fan - Step Type with Bar Knob - 2 Module	1327.00
C5901 .02	Fan Regulator for 80W fan - Step Type with Round Knob - 2 Module	1268.00
C5910 .02	Fan Regulator for 120W fan - Step Type with Bar Knob - 2 Module	1459.00
C5911 .02	Fan Regulator for 120W fan - Step Type with Round Knob - 2 Module	1406.00
C5912 .02	Fan Regulator for 120W fan - 8-Step Type with Bar Knob - 2 Module	1488.00
C5913 .02	Fan Regulator for 120W fan - 8-Step Type with Round Knob - 2 Module	1435.00
C5902 .02	Dimmer 500 Watts - 2 Module	1067.00
C5903 .02	Dimmer 1000 Watts - 2 Module	1495.00
C5904 .02	Fan Regulator Single Module for 80W Fan - Step Type - 1 Module	870.00
C5905 .02	Dimmer 500 Watts - 1 Module	822.00
C5908 .02	Dimmer for LED Lights 100W (3 wire system) - 1 Module	817.00
C5909 .02	Dimmer for LED Lights with Digital Choke 100W (4 wire system) - 2M	1067.00

* Only for export outside India



C5707 .02
C5708 .02



C5703 .01
C5704 .01
C5705 .01
C5505 .01



C5715 .02
C5716 .02



C5727 .02

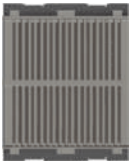

C5706 .02
C5709 .02



C5721 .02



C5710 .02

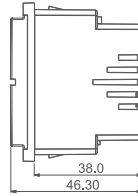

CUBE Series

Acoustic & Optical Signaling Quartz Gray

Cat no.	Description	Price (Rs.)
C5707 .02	Electronic Bell - 2 Module	842.00
C5727 .02	Indicator Light - 1 Module	381.00
C5703 .01	Prismatic Overdoor Bulkhead Indicator - White - 2 Module	615.00
C5704 .01	Prismatic Overdoor Bulkhead Indicator - Green - 2 Module	635.00
C5705 .01	Prismatic Overdoor Bulkhead Indicator - Red - 2 Module	635.00
C5505 .01	Prismatic Overdoor Bulkhead Indicator - Resettable - 2 Module	960.00
C5715 .02	Emergency Light - 2 Module	2042.00
C5706 .02	Speaker for audio music circuit - 2 Module	1483.00
C5716 .02	Night Light with switch and dimming option - 2 Module	1296.00
C5721 .02	Step Marker Lamp/ Night Lamp - 2 Module	854.00
C5709 .02	Electronic Buzzer - 2 Module	761.00
C5710 .02	Electronic Buzzer - 1 Module	672.00
C5708 .02	Ultrasonic Mosquito Repellent - 2 Module	1203.00



C5712 .02



C5460 .02

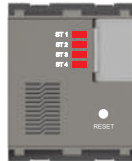

C5711 .02



C5262 .02
C5263 .02

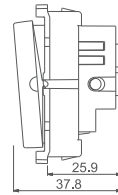

C5450 .02



C5906 .02



C5233 .02



C5232 .02

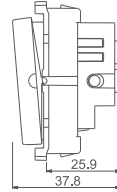

C5718 .02



C5723 .02



C5719 .02

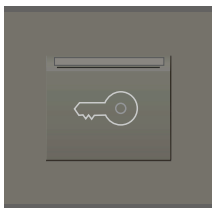
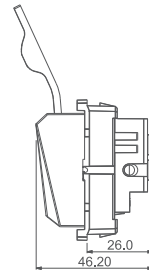

C5717 .02

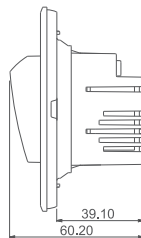

CUBE Series

Hospitality Modules Quartz Gray

Cat no.	Description	Price (Rs.)
C5717 .02	25A Smart Card operated Electronic switch in 2 Module with indicator & exit time delay feature including Smart Card - 2 Module	3335.00
C5718 .02	30A Smart Card operated Electronic switch in 3 Module with indicator & exit time delay feature including Smart Card - 3 Module	3218.00
C5724 .02	Smart Card - Customized	222.00
C5719 .02	25A Key Fob Switch Double Pole with indicator - 2 Module	1721.00
C5720 .02	Key Fob - Customized	255.00
C5723 .02	Shaver Socket 220V/110V - 3 Module	3058.00
C5711 .02	Call Bell Station with Register and provision for External Buzzer - 2M	1737.00
C5712 .02	External Buzzer for Call Bell Station - 2 Module	690.00
C5232 .02	“Do Not Disturb” Switch with indicator - 1 Module	546.00
C5233 .02	“Clean My Room” Switch with indicator - 1 Module	546.00
C5906 .02	Volume Control 100 Ohms 1 Watt - 2 Module	946.00
C5262 .02	Bell Switch with “Do Not Disturb” & “Clean My Room” Indicator - 2M	929.00
C5263 .02	Bell Switch with “DND”, “CMR” & Guest is in Indicator - 2M	1002.00
C5450 .02	Push Button station (Start - Stop) - 2 Module	763.00
C5460 .02	Curtain Control Switch 6A - 2 Module	847.00



C5729 .02



C5739 .02



C5800 .02
C5809 .02



C5701 .02



C5700 .02



C5802 .02
C5803 .02

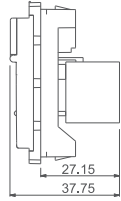

C5725 .02
C5736 .02



C5836 .02
C5837 .02



C5797 .02



C5500 .02



C5798 .02



C5820 .02

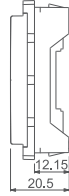

C5936 .02
C5938 .02



C5939 .02

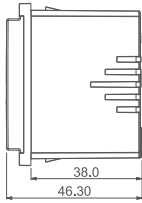

CUBE Series

Communiqué & Support Modules Quartz Gray

Cat no.	Description	Price (Rs.)
C5797 .02	Coaxial T.V Socket - 1 Module	293.00
C5725 .02	USB Extension Socket - 1 Module	696.00
C5736 .02	USB Charger Socket Outlet A Type - 2.1 Amps - 1 Module	3118.00
C5836 .02	USB Charger Socket Outlet C Type - 2.1 Amps - 1 Module	3448.00
C5936 .02	USB Charger Socket Outlet A+C Type - 2.1 Amps - 1 Module	3762.00
C5837 .02	USB Charger Socket Outlet C Type - 3.1 Amps - 1 Module	3750.00
C5938 .02	USB Charger Socket Outlet A+C Type - 3.1 Amps - 1 Module	4022.00
C5939 .02	USB Charger Socket Outlet C+C Type - 3.1 Amps - 1 Module	4190.00
C5729 .02	Computer Monitor Output Socket - 1 Module	484.00
C5739 .02	HDMI Socket - 1 Module	1894.00
C5800 .02	Telephone Socket RJ-11 Double Line Shuttered - 1 Module	282.00
C5820 .02	Twin Telephone Socket RJ-11 - 1 Module	453.00
C5802 .02	Information Socket 6e - UTP Shuttered - 1 Module	1035.00
C5803 .02	Information Socket 6a - UTP Shuttered - 1 Module	1747.00
C5701 .02	Triple RCA Audio Visual Socket - 1 Module	957.00
C5500 .02	Cord Outlet - 1 Module	212.00
C5700 .02	Blanking Plate - 1 Module	75.00
C5798 .02	Audio Port / Jack 3.5mm - 1 Module	554.00
C5809 .02	Fitment for RJ-45 Computer Socket Shuttered - 1 Module	312.00



V5110 .02
V5210 .02
V5130 .02
V5230 .02



V5111 .02
V5211 .02
V5131 .02
V5231 .02



V5140 .02
V5240 .02
V5160 .02
V5180 .02



V5141 .02
V5241 .02
V5161 .02
V5261 .02



V5281 .02
V5191 .02
V5291 .02
V5171 .02



V5340 .02
V5341 .02

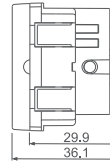

V5901 .02
V5911 .02



V5913 .02



V5900 .02
V5910 .02
V5912 .02

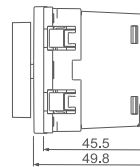

Vertical Switches and Vertical Fan Regulators can be mounted on all types of standard Cube Series Plates. Metal Boxes, Frames and Plates need to be fixed in the vertical position as shown here.

CUBE Series

Vertical Switches Quartz Gray

Cat no.	Description	Price (Rs.)
V5110 .02	Vertical Switches - 2 Gang - Both switches 6A 1 way - 2 Module	490.00
V5111 .02	Vertical Switches - 2 Gang - Both switches 6A 1 way with indicator - 2M	642.00
V5210 .02	Vertical Switches - 2 Gang - Both switches 6A 2 way - 2 Module	589.00
V5211 .02	Vertical Switches - 2 Gang - Both switches 6A 2 way with indicator - 2M	838.00
V5130 .02	Vertical Switches - 2 Gang - Both switches 16A 1 way - 2 Module	693.00
V5131 .02	Vertical Switches - 2 Gang - Both switches 16A 1 way with indicator - 2M	878.00
V5230 .02	Vertical Switches - 2 Gang - Both switches 16A 2 way - 2 Module	733.00
V5231 .02	Vertical Switches - 2 Gang - Both switches 16A 2 way with indicator - 2M	958.00
V5140 .02	Vertical Palm Switch 6A 1 way Single Pole - 2 Module	268.00
V5141 .02	Vertical Palm Switch 6A 1 way Single Pole with indicator - 2 Module	344.00
V5240 .02	Vertical Palm Switch 6A 2 way Single Pole - 2 Module	303.00
V5241 .02	Vertical Palm Switch 6A 2 way Single Pole with indicator - 2 Module	434.00
V5160 .02	Vertical Palm Switch 16A 1 way Single Pole - 2 Module	354.00
V5161 .02	Vertical Palm Switch 16A 1 way Single Pole with indicator - 2 Module	434.00
V5261 .02	Vertical Palm Switch 16A 2 way Single Pole with indicator - 2 Module	509.00
V5180 .02	Vertical Palm Switch 6A 1 way Double Pole - 2 Module	493.00
V5281 .02	Vertical Palm Switch 6A 2 way Double Pole with indicator - 2 Module	589.00
V5191 .02	Vertical Palm Switch 16A 1 way Double Pole with indicator - 2 Module	695.00
V5291 .02	Vertical Palm Switch 16A 2 way Double Pole with indicator - 2 Module	827.00
V5171 .02	Vertical Palm Switch 25A 1 way Double Pole with indicator - 2 Module	829.00
V5340 .02	Vertical Palm Bell Switch Single Pole - 2 Module	363.00
V5341 .02	Vertical Palm Bell Switch Single Pole with indicator - 2 Module	472.00

51

Vertical Fan Regulators & Dimmers Quartz Gray

V5900 .02	Vertical Fan Regulator for 80W fan - Step Type with Bar Knob - 2M	1329.00
V5901 .02	Vertical Fan Regulator for 80W fan - Step Type with Round Knob - 2M	1268.00
V5910 .02	Vertical Fan Regulator for 120W fan - Step Type with Bar Knob - 2M	1460.00
V5911 .02	Vertical Fan Regulator for 120W fan - Step Type with Round Knob - 2M	1406.00
V5912 .02	Vertical Fan Regulator for 120W fan - 8-Step Type with Bar Knob - 2M	1488.00
V5913 .02	Vertical Fan Regulator for 120W fan - 8-Step Type with Round Knob-2M	1435.00
V5902 .02	Vertical Dimmer 500 Watts - 2 Module	1067.00



C5110 .17
C5130 .17
C5730 .17



C5210 .17
C5230 .17



C5310 .17



C5441 .17

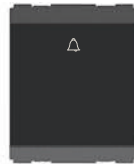

C5340 .17

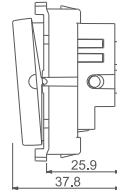

C5111 .17
C5131 .17
C5731 .17



C5211 .17
C5231 .17



C5311 .17



C5431 .17

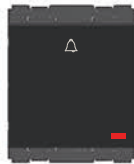

C5341 .17

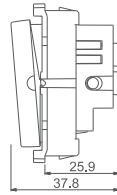

52



C5140 .17
C5160 .17



C5180 .17



C5240 .17
C5260 .17



C5280 .17

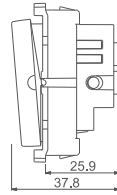

C5141 .17
C5161 .17



C5191 .17
C5171 .17

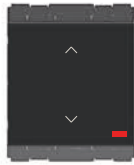

C5241 .17
C5261 .17

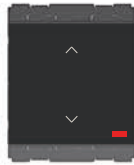

C5281 .17
C5291 .17

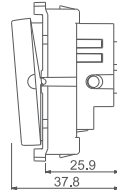

CUBE Series

Switches Charcoal Black

Cat no.	Description	Price (Rs.)
C5110 .17	Switch 6A One-way - 1 Module	214.00
C5111 .17	Switch 6A One-way with indicator - 1 Module	362.00
C5210 .17	Switch 6A Two-way - 1 Module	326.00
C5211 .17	Switch 6A Two-way with indicator - 1 Module	499.00
C5130 .17	Switch 16A One-way - 1 Module	387.00
C5131 .17	Switch 16A One-way with indicator - 1 Module	482.00
C5230 .17	Switch 16A Two-way - 1 Module	402.00
C5231 .17	Switch 16A Two-way with indicator - 1 Module	518.00
C5730 .17	Switch 25A One-way - 1 Module	539.00
C5731 .17	Switch 25A One-way with indicator - 1 Module	636.00
C5310 .17	Switch 6A - Bell - 1 Module	335.00
C5311 .17	Switch 6A - Bell with indicator - 1 Module	463.00
C5140 .17	Palm Switch 6A One-way Single Pole - 2 Module	287.00
C5141 .17	Palm Switch 6A One-way Single Pole with indicator - 2 Module	373.00
C5240 .17	Palm Switch 6A Two-way Single Pole - 2 Module	332.00
C5241 .17	Palm Switch 6A Two-way Single Pole with indicator - 2 Module	471.00
C5160 .17	Palm Switch 16A One-way Single Pole - 2 Module	388.00
C5161 .17	Palm Switch 16A One-way Single Pole with indicator - 2 Module	471.00
C5260 .17	Palm Switch 16A Two-way Single Pole - 2 Module	422.00
C5261 .17	Palm Switch 16A Two-way Single Pole with indicator - 2 Module	549.00
C5180 .17	Palm Switch 6A One-way Double Pole - 2 Module	540.00
C5280 .17	Palm Switch 6A Two-way Double Pole - 2 Module	576.00
C5281 .17	Palm Switch 6A Two-way Double Pole with indicator - 2 Module	637.00
C5191 .17	Palm Switch 16A One-way Double Pole with indicator - 2 Module	752.00
C5291 .17	Palm Switch 16A Two-way Double Pole with indicator - 2 Module	894.00
C5171 .17	Palm Switch 25A One-way Double Pole with indicator - 2 Module	897.00
C5340 .17	Palm Bell Switch Single Pole - 2 Module	397.00
C5341 .17	Palm Bell Switch Single Pole with indicator - 2 Module	513.00
C5441 .17	Switch 16A One-way with 'Geyser' Symbol with indicator - 1 Module	492.00
C5431 .17	Switch 6A One-way with 'Fan' or 'Light' or 'Exhaust' symbol - 1 Module	373.00



C2110.17



C2111.17



C2010.17



C2011.17

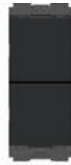

C2130.17



C2131.17



C2030.17



C2031.17



C2140.17



C2141.17



C2040.17



C2041.17



CUBE Series

Twin Switches Charcoal Black

Cat no.	Description	Price (Rs.)
C2110 .17	Twin Switch 6A - 2 Gang - Both switches 1 way - 1 Module	667.00
C2111 .17	Twin Switch 6A - 2 Gang - Both switches 1 way with indicator- 1Module	1032.00
C2010 .17	Twin Switch 6A - 1 Gang - 2 way + Dummy - 1 Module	768.00
C2011 .17	Twin Switch 6A - 1 Gang - 2 way with indicator + Dummy - 1 Module	1078.00
C2130 .17	Twin Switch 16A - 2 Gang - Both switches 1 way - 1 Module	1109.00
C2131 .17	Twin Switch 16A - 2 Gang - Both switches 1 way with indicator- 1 Module	1391.00
C2030 .17	Twin Switch 16A - 1 Gang - 2 way + Dummy - 1 Module	1052.00
C2031 .17	Twin Switch 16A - 1 Gang - 2 way with indicator + Dummy - 1 Module	1329.00
C2140 .17	Twin Switch 6A - 2 Gang - Both Switches Bell - 1 Module	1043.00
C2141 .17	Twin Switch 6A - 2 Gang - Both Switches Bell with Indicator - 1 Module	1378.00
C2040 .17	Twin Switch 6A - 1 Gang - 1 Bell + 1 Dummy - 1 Module	840.00
C2041 .17	Twin Switch 6A - 1 Gang - 1 Bell with Indicator + 1 Dummy - 1 Module	1099.00



C5213 .17



C5331 .17



C5332 .17



C5552 .17

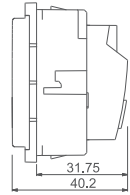

C5212 .17



C5532 .17



C5531 .17



C5752 .17

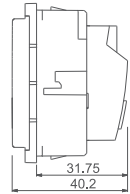

C5010 .17

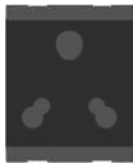

C5732 .17



C5733 .17



C5902 .17

C5903 .17

C5909 .17

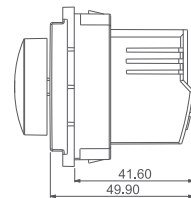

C5904 .17



C5905 .17

C5908 .17



C5900 .17

C5910 .17

C5912 .17



C5901 .17

C5911 .17



C5913 .17

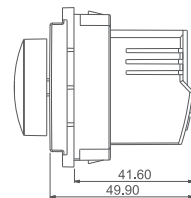

CUBE Series

Sockets Charcoal Black

Cat no.	Description	Price (Rs.)
C5213 .17	Socket 6A 3-Pin-only Shuttered - 2 Module (As per Indian Standard)	422.00
C5332 .17	Socket 16A and 6A 3-Pin Shuttered - 2 Module (As per Indian Standard)	580.00
C5552 .17	Socket 16A and 6A 3-Pin Shuttered - 3 Module (As per Indian Standard)	667.00
C5331 .17	Socket 16A 3-Pin-only Shuttered - 2 Module (As per Indian Standard)	541.00
C5212 .17	Socket 6A 3+2 Pin [Round & Flat] Shuttered - 2 Module *	467.00
C5010 .17	Socket 6A 2 Pin [Round & Flat] - 1 Module *	318.00
C5532 .17	Socket 13A International Multi socket Shuttered - 2 Module *	580.00
C5531 .17	Socket 13A 3-Pin Flat-only Socket Shuttered - 2 Module *	549.00
C5732 .17	Socket 25A and 6A 3-Pin Shuttered - 2 Module *	661.00
C5752 .17	Socket 25A and 6A 3-Pin Shuttered - 3 Module *	779.00
C5733 .17	Socket 25A 3-Pin-only Shuttered - 2 Module *	624.00

Fan Regulators & Dimmers Charcoal Black

57

C5900 .17	Fan Regulator for 80W fan - Step Type with Bar Knob - 2 Module	1464.00
C5901 .17	Fan Regulator for 80W fan - Step Type with Round Knob - 2 Module	1403.00
C5910 .17	Fan Regulator for 120W fan - Step Type with Bar Knob - 2 Module	1611.00
C5911 .17	Fan Regulator for 120W fan - Step Type with Round Knob - 2 Module	1550.00
C5912 .17	Fan Regulator for 120W fan - 8-Step Type with Bar Knob - 2 Module	1643.00
C5913 .17	Fan Regulator for 120W fan - 8-Step Type with Round Knob - 2 Module	1581.00
C5902 .17	Dimmer 500 Watts - 2 Module	1177.00
C5903 .17	Dimmer 1000 Watts - 2 Module	1647.00
C5904 .17	Fan Regulator Single Module for 80W Fan - Step Type - 1 Module	964.00
C5905 .17	Dimmer 500 Watts - 1 Module	907.00
C5908 .17	Dimmer for LED Lights 100W (3 wire system) - 1 Module	903.00
C5909 .17	Dimmer for LED Lights with Digital Choke 100W (4 wire system) - 2M	1177.00

* Only for export outside India



C5707 .17
C5708 .17



C5703 .01
C5704 .01
C5705 .01
C5505 .01



C5715 .17
C5716 .17



C5727 .17



C5706 .17
C5709 .17



C5721 .17



C5710 .17

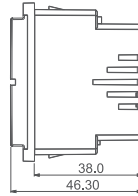

CUBE Series

Acoustic & Optical Signaling Charcoal Black

Cat no.	Description	Price (Rs.)
C5707 .17	Electronic Bell - 2 Module	911.00
C5727 .17	Indicator Light - 1 Module	415.00
C5703 .01	Prismatic Overdoor Bulkhead Indicator - White - 2 Module	615.00
C5704 .01	Prismatic Overdoor Bulkhead Indicator - Green - 2 Module	635.00
C5705 .01	Prismatic Overdoor Bulkhead Indicator - Red - 2 Module	635.00
C5505 .01	Prismatic Overdoor Bulkhead Indicator - Resettable - 2 Module	960.00
C5715 .17	Emergency Light - 2 Module	2212.00
C5706 .17	Speaker for audio music circuit - 2 Module	1609.00
C5716 .17	Night Light with switch and dimming option - 2 Module	1403.00
C5721 .17	Step Marker Lamp/ Night Lamp - 2 Module	927.00
C5709 .17	Electronic Buzzer - 2 Module	825.00
C5710 .17	Electronic Buzzer - 1 Module	731.00
C5708 .17	Ultrasonic Mosquito Repellent - 2 Module	1302.00



C5712 .17



C5460 .17



C5711 .17



C5262 .17
C5263 .17

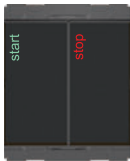
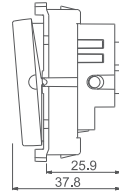

C5450 .17

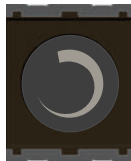

C5906 .17



C5233 .17

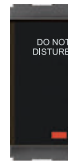

C5232 .17

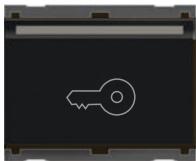
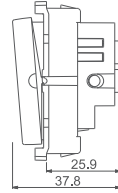

C5718 .17

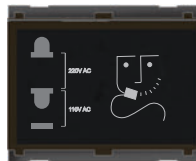

C5723 .17



C5719 .17

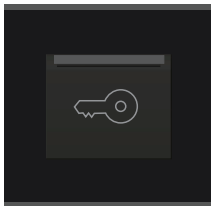
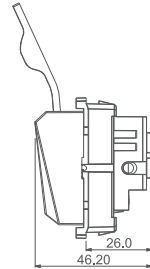

C5717 .17

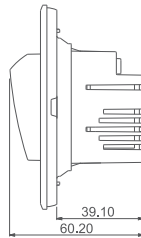

CUBE Series

Hospitality Modules Charcoal Black

Cat no.	Description	Price (Rs.)
C5717 .17	25A Smart Card operated Electronic switch in 2 Module with indicator & exit time delay feature including Smart Card - 2 Module	3939.00
C5718 .17	30A Smart Card operated Electronic switch in 3 Module with indicator & exit time delay feature including Smart Card - 3 Module	3801.00
C5724 .17	Smart Card - Customized	288.00
C5719 .17	25A Key Fob Switch Double Pole with indicator - 2 Module	1852.00
C5720 .17	Key Fob - Customized	294.00
C5723 .17	Shaver Socket 220V/110V - 3 Module	3608.00
C5711 .17	Call Bell Station with Register and provision for External Buzzer - 2M	2044.00
C5712 .17	External Buzzer for Call Bell Station - 2 Module	751.00
C5232 .17	"Do Not Disturb" Switch with indicator - 1 Module	588.00
C5233 .17	"Clean My Room" Switch with indicator - 1 Module	588.00
C5906 .17	Volume Control 100 Ohms 1 Watt - 2 Module	979.00
C5262 .17	Bell Switch with "Do Not Disturb" & "Clean My Room" Indicator - 2M	951.00
C5263 .17	Bell Switch with "DND", "CMR" & Guest is in Indicator - 2M	1084.00
C5450 .17	Push Button station (Start - Stop) - 2 Module	820.00
C5460 .17	Curtain Control Switch 6A - 2 Module	907.00



C5729 .17



C5739 .17



C5800 .17
C5809 .17



C5701 .17



C5700 .17



C5802 .17
C5803 .17

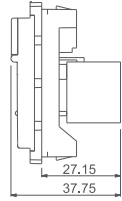

C5725 .17
C5736 .17



C5836 .17
C5837 .17



C5797 .17



C5500 .17



C5798 .17



C5820 .17

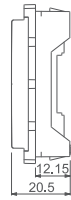

C5936 .17
C5938 .17



C5939 .17



C5110 .20



C5111 .20
C5131 .20
C5731 .20



C5171 .20

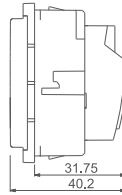

C5212 .20

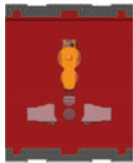

C5532 .20

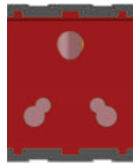

C5332 .20



C5732 .20

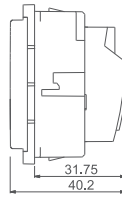

CUBE Series

Communiqué & Support Modules Charcoal Black

Cat no.	Description	Price (Rs.)
C5797 .17	Coaxial T.V Socket - 1 Module	318.00
C5725 .17	USB Extension Socket - 1 Module	755.00
C5736 .17	USB Charger Socket Outlet A Type - 2.1 Amps - 1 Module	3378.00
C5836 .17	USB Charger Socket Outlet C Type - 2.1 Amps - 1 Module	3736.00
C5936 .17	USB Charger Socket Outlet A+C Type - 2.1 Amps - 1 Module	4076.00
C5837 .17	USB Charger Socket Outlet C Type - 3.1 Amps - 1 Module	4062.00
C5938 .17	USB Charger Socket Outlet A+C Type - 3.1 Amps - 1 Module	4357.00
C5939 .17	USB Charger Socket Outlet C+C Type - 3.1 Amps - 1 Module	4537.00
C5729 .17	Computer Monitor Output Socket - 1 Module	525.00
C5739 .17	HDMI Socket - 1 Module	2052.00
C5800 .17	Telephone Socket RJ-11 Double Line Shuttered - 1 Module	304.00
C5820 .17	Twin Telephone Socket RJ-11 - 1 Module	491.00
C5802 .17	Information Socket 6e - UTP Shuttered - 1 Module	1125.00
C5803 .17	Information Socket 6a - UTP Shuttered - 1 Module	1894.00
C5701 .17	Triple RCA Audio Visual Socket - 1 Module	1039.00
C5500 .17	Cord Outlet - 1 Module	231.00
C5700 .17	Blanking Plate - 1 Module	83.00
C5798 .17	Audio Port / Jack 3.5mm - 1 Module	602.00
C5809 .17	Fitment for RJ-45 Computer Socket Shuttered - 1 Module	339.00

63

Dedicated Modules Scarlet Red

C5110 .20	Switch 6A One-way - 1 Module	257.00
C5111 .20	Switch 6A One-way with indicator - 1 Module	362.00
C5131 .20	Switch 16A One-way with indicator - 1 Module	489.00
C5731 .20	Switch 25A One-way with indicator - 1 Module	636.00
C5171 .20	Palm Switch 25A One-way Double Pole with indicator - 2 Module	897.00
C5212 .20	Socket 6A 3+2 Pin [Round & Flat] Shuttered - 2 Module *	467.00
C5532 .20	Socket 13A International Multi socket Shuttered - 2 Module *	580.00
C5332 .20	Socket 16A and 6A 3-Pin Shuttered - 2 Module (As per Indian Standard)	580.00
C5732 .20	Socket 25A and 6A 3-Pin Shuttered - 2 Module *	659.00

* Only for export outside India



V5110 .17
V5210 .17
V5130 .17
V5230 .17



V5111 .17
V5211 .17
V5131 .17
V5231 .17



V5140 .17
V5240 .17
V5160 .17
V5180 .17

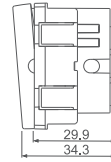

V5141 .17
V5241 .17
V5161 .17
V5261 .17



V5281 .17
V5191 .17
V5291 .17
V5171 .17



V5340 .17
V5341 .17

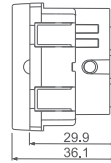

64



V5901 .17
V5911 .17



V5913 .17



V5900 .17
V5910 .17
V5912 .17

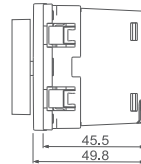

Vertical Switches and Vertical Fan Regulators can be mounted on all types of standard Cube Series Plates. Metal Boxes, Frames and Plates need to be fixed in the vertical position as shown here.

CUBE Series

Vertical Switches Charcoal Black

Cat no.	Description	Price (Rs.)
V5110 .17	Vertical Switches - 2 Gang - Both switches 6A 1 way - 2 Module	529.00
V5111 .17	Vertical Switches - 2 Gang - Both switches 6A 1 way with indicator - 2M	700.00
V5210 .17	Vertical Switches - 2 Gang - Both switches 6A 2 way - 2 Module	645.00
V5211 .17	Vertical Switches - 2 Gang - Both switches 6A 2 way with indicator - 2M	932.00
V5130 .17	Vertical Switches - 2 Gang - Both switches 16A 1 way - 2 Module	762.00
V5131 .17	Vertical Switches - 2 Gang - Both switches 16A 1 way with indicator - 2M	958.00
V5230 .17	Vertical Switches - 2 Gang - Both switches 16A 2 way - 2 Module	804.00
V5231 .17	Vertical Switches - 2 Gang - Both switches 16A 2 way with indicator- 2M	1047.00
V5140 .17	Vertical Palm Switch 6A 1 way Single Pole - 2 Module	293.00
V5141 .17	Vertical Palm Switch 6A 1 way Single Pole with indicator - 2 Module	376.00
V5240 .17	Vertical Palm Switch 6A 2 way Single Pole - 2 Module	333.00
V5241 .17	Vertical Palm Switch 6A 2 way Single Pole with indicator - 2 Module	475.00
V5160 .17	Vertical Palm Switch 16A 1 way Single Pole - 2 Module	387.00
V5161 .17	Vertical Palm Switch 16A 1 way Single Pole with indicator - 2 Module	475.00
V5261 .17	Vertical Palm Switch 16A 2 way Single Pole with indicator - 2 Module	554.00
V5180 .17	Vertical Palm Switch 6A 1 way Double Pole - 2 Module	540.00
V5281 .17	Vertical Palm Switch 6A 2 way Double Pole with indicator - 2 Module	643.00
V5191 .17	Vertical Palm Switch 16A 1 way Double Pole with indicator - 2 Module	759.00
V5291 .17	Vertical Palm Switch 16A 2 way Double Pole with indicator - 2 Module	903.00
V5171 .17	Vertical Palm Switch 25A 1 way Double Pole with indicator - 2 Module	906.00
V5340 .17	Vertical Palm Bell Switch Single Pole - 2 Module	397.00
V5341 .17	Vertical Palm Bell Switch Single Pole with indicator - 2 Module	518.00

65

Vertical Fan Rgulators & Dimmers Charcoal Black

V5900 .17	Vertical Fan Regulator for 80W fan - Step Type with Bar Knob - 2M	1464.00
V5901 .17	Vertical Fan Regulator for 80W fan - Step Type with Round Knob - 2M	1403.00
V5910 .17	Vertical Fan Regulator for 120W fan - Step Type with Bar Knob - 2M	1609.00
V5911 .17	Vertical Fan Regulator for 120W fan - Step Type with Round Knob - 2M	1552.00
V5912 .17	Vertical Fan Regulator for 120W fan - 8-Step Type with Bar Knob - 2M	1643.00
V5913 .17	Vertical Fan Regulator for 120W fan - 8-Step Type with Round Knob-2M	1581.00
V5902 .17	Vertical Dimmer 500 Watts - 2 Module	1177.00



C5101 .01 C5101 .16
 C5101 .02 C5101 .17
 C5101 .03 C5101 .25



C5102 .01 C5102 .16
 C5102 .02 C5102 .17
 C5102 .03 C5102 .25



C5103 .01 C5103 .16
 C5103 .02 C5103 .17
 C5103 .03 C5103 .25

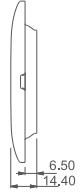

C5104 .01 C5104 .16
 C5104 .02 C5104 .17
 C5104 .03 C5104 .25



C5106 .01 C5106 .16
 C5106 .02 C5106 .17
 C5106 .03 C5106 .25

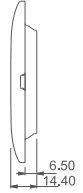

66



C5108 .01 C5108 .16
 C5108 .02 C5108 .17
 C5108 .03 C5108 .25

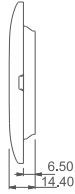

C5109 .01 C5109 .16
 C5109 .02 C5109 .17
 C5109 .03 C5109 .25



C5112 .01 C5112 .16
 C5112 .02 C5112 .17
 C5112 .03 C5112 .25

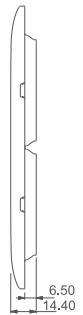

Image for 14M Plate and 21M Plate are not shown here

CUBE Series

Smart plates with frames Frost White, Quartz Gray and Ice Silver

Description	Frost White		Quartz Gray		Ice Silver	
	Cat no.	Price	Cat no.	Price	Cat no.	Price
1M Plate	C5101 .01	159.00	C5101 .02	251.00	C5101 .03	251.00
2M Plate	C5102 .01	168.00	C5102 .02	264.00	C5102 .03	264.00
3M Plate	C5103 .01	183.00	C5103 .02	288.00	C5103 .03	288.00
4M Plate	C5104 .01	195.00	C5104 .02	308.00	C5104 .03	308.00
6M Plate	C5106 .01	348.00	C5106 .02	555.00	C5106 .03	555.00
8M Plate	C5108 .01	385.00	C5108 .02	611.00	C5108 .03	611.00
8M (V) Plate	C5109 .01	449.00	C5109 .02	712.00	C5109 .03	712.00
12M Plate	C5112 .01	545.00	C5112 .02	865.00	C5112 .03	865.00
14M Plate	C5114 .01	623.00	C5114 .02	996.00	C5114 .03	996.00
21M Plate	C5121 .01	787.00	C5121 .02	1443.00	C5121 .03	1443.00

67

Smart plates with frames Matt Gold, Charcoal Black and Cocoa Brown

Description	Matt Gold		Charcoal Black		Cocoa Brown	
	Cat no.	Price	Cat no.	Price	Cat no.	Price
1M Plate	C5101 .16	301.00	C5101 .17	304.00	C5101 .25	304.00
2M Plate	C5102 .16	318.00	C5102 .17	320.00	C5102 .25	320.00
3M Plate	C5103 .16	346.00	C5103 .17	349.00	C5103 .25	349.00
4M Plate	C5104 .16	370.00	C5104 .17	373.00	C5104 .25	373.00
6M Plate	C5106 .16	666.00	C5106 .17	673.00	C5106 .25	673.00
8M Plate	C5108 .16	734.00	C5108 .17	740.00	C5108 .25	740.00
8M (V) Plate	C5109 .16	854.00	C5109 .17	861.00	C5109 .25	861.00
12M Plate	C5112 .16	1038.00	C5112 .17	1048.00	C5112 .25	1048.00
14M Plate	C5114 .16	1196.00	C5114 .17	1206.00	C5114 .25	1206.00
21M Plate	C5121 .16	1732.00	C5121 .17	1747.00	C5121 .25	1747.00



C5401 .01 C5401 .16
 C5401 .02 C5401 .17
 C5401 .03 C5401 .25



C5402 .01 C5402 .16
 C5402 .02 C5402 .17
 C5402 .03 C5402 .25



C5403 .01 C5403 .16
 C5403 .02 C5403 .17
 C5403 .03 C5403 .25

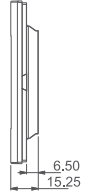

C5404 .01 C5404 .16
 C5404 .02 C5404 .17
 C5404 .03 C5404 .25



C5406 .01 C5406 .16
 C5406 .02 C5406 .17
 C5406 .03 C5406 .25

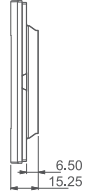

68



C5408 .01 C5408 .16
 C5408 .02 C5408 .17
 C5408 .03 C5408 .25

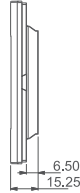

C5409 .01 C5409 .16
 C5409 .02 C5409 .17
 C5409 .03 C5409 .25



C5412 .01 C5412 .16
 C5412 .02 C5412 .17
 C5412 .03 C5412 .25

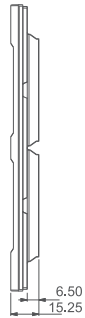

Images for 14M Plate, 16M Plate and 21M Plate are not shown here

CUBE Series

Vector plates with frames Frost White, Quartz Gray and Ice Silver

Description	Frost White		Quartz Gray		Ice Silver	
	Cat no.	Price	Cat no.	Price	Cat no.	Price
1M Plate	C5401 .01	173.00	C5401 .02	263.00	C5401 .03	263.00
2M Plate	C5402 .01	180.00	C5402 .02	277.00	C5402 .03	277.00
3M Plate	C5403 .01	197.00	C5403 .02	305.00	C5403 .03	305.00
4M Plate	C5404 .01	210.00	C5404 .02	324.00	C5404 .03	324.00
6M Plate	C5406 .01	379.00	C5406 .02	583.00	C5406 .03	583.00
8M Plate	C5408 .01	416.00	C5408 .02	642.00	C5408 .03	642.00
8M (V) Plate	C5409 .01	485.00	C5409 .02	747.00	C5409 .03	747.00
12M Plate	C5412 .01	592.00	C5412 .02	909.00	C5412 .03	909.00
14M Plate	C5414 .01	689.00	C5414 .02	1060.00	C5414 .03	1060.00
16M Plate	C5416 .01	725.00	C5416 .02	1116.00	C5416 .03	1116.00
21M Plate	C5421 .01	870.00	C5421 .02	1537.00	C5421 .03	1537.00

69

Vector plates with frames Matt Gold, Charcoal Black and Cocoa Brown

Description	Matt Gold		Charcoal Black		Cocoa Brown	
	Cat no.	Price	Cat no.	Price	Cat no.	Price
1M Plate	C5401 .16	316.00	C5401 .17	324.00	C5401 .25	324.00
2M Plate	C5402 .16	352.00	C5402 .17	364.00	C5402 .25	364.00
3M Plate	C5403 .16	377.00	C5403 .17	395.00	C5403 .25	395.00
4M Plate	C5404 .16	408.00	C5404 .17	425.00	C5404 .25	425.00
6M Plate	C5406 .16	700.00	C5406 .17	726.00	C5406 .25	726.00
8M Plate	C5408 .16	772.00	C5408 .17	783.00	C5408 .25	783.00
8M (V) Plate	C5409 .16	896.00	C5409 .17	944.00	C5409 .25	944.00
12M Plate	C5412 .16	1091.00	C5412 .17	1128.00	C5412 .25	1128.00
14M Plate	C5414 .16	1273.00	C5414 .17	1298.00	C5414 .25	1298.00
16M Plate	C5416 .16	1341.00	C5416 .17	1418.00	C5416 .25	1418.00
21M Plate	C5421 .16	1844.00	C5421 .17	1940.00	C5421 .25	1940.00



C6401 .01 C6401 .03
C6401 .02 C6401 .16



C6402 .01 C6402 .03
C6402 .02 C6402 .16



C6403 .01 C6403 .03
C6403 .02 C6403 .16

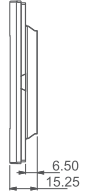

C6404 .01 C6404 .03
C6404 .02 C6404 .16



C6406 .01 C6406 .03
C6406 .02 C6406 .16

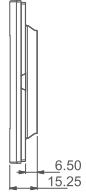

70



C6408 .01 C6408 .03
C6408 .02 C6408 .16

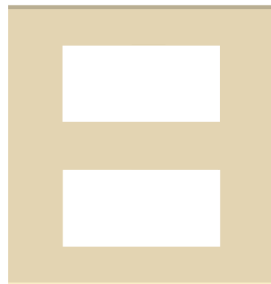
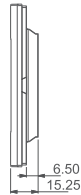

C6409 .01 C6409 .03
C6409 .02 C6409 .16

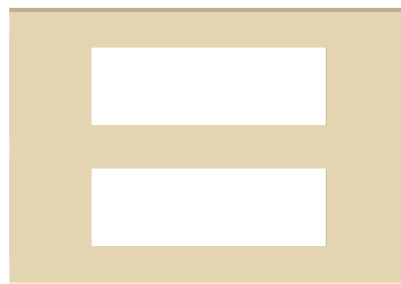

C6412 .01 C6412 .03
C6412 .02 C6412 .16

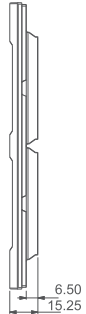

Images for 14M Plate, 16M Plate and 21M Plate are not shown here

CUBE Series

Flat'5 plates with frames Frost White and Quartz Gray

Description	Frost White		Quartz Gray	
	Cat no.	Price	Cat no.	Price
1M Plate - for 75mm x 75mm box (3x3)	C6401 .01	236.00	C6401 .02	421.00
2M Plate - for 75mm x 75mm box (3x3)	C6402 .01	250.00	C6402 .02	458.00
3M Plate - for 100mm x 75mm box (4x3)	C6403 .01	277.00	C6403 .02	506.00
4M Plate - for 135mm x 75mm box (5x3)	C6404 .01	295.00	C6404 .02	538.00
6M Plate - for 210mm x 75mm box (8x3)	C6406 .01	531.00	C6406 .02	972.00
8M Plate - for 230/210 x 75mm box (9x3 or 8x3)	C6408 .01	591.00	C6408 .02	1078.00
8M (V) Plate - for 135mm x 140mm box (5x5)	C6409 .01	785.00	C6409 .02	1391.00
12M Plate - for 140mm x 210mm box (8x6)	C6412 .01	907.00	C6412 .02	1663.00
14M Plate - for 140mm x 210mm box (8x6)	C6414 .01	1070.00	C6414 .02	1956.00
16M Plate - for 230x145mm box (10x6 or 9x6)	C6416 .01	1198.00	C6416 .02	2196.00
21M Plate - for 210mm x 210mm box (8x8)	C6421 .01	1371.00	C6421 .02	2524.00

71

Flat'5 plates with frames Ice Silver and Matt Gold

Description	Ice Silver		Matt Gold	
	Cat no.	Price	Cat no.	Price
1M Plate - for 75mm x 75mm box (3x3)	C6401 .03	421.00	C6401 .16	507.00
2M Plate - for 75mm x 75mm box (3x3)	C6402 .03	458.00	C6402 .16	581.00
3M Plate - for 100mm x 75mm box (4x3)	C6403 .03	506.00	C6403 .16	628.00
4M Plate - for 135mm x 75mm box (5x3)	C6404 .03	538.00	C6404 .16	676.00
6M Plate - for 210mm x 75mm box (8x3)	C6406 .03	972.00	C6406 .16	1168.00
8M Plate - for 230/210 x 75mm box (9x3 or 8x3)	C6408 .03	1078.00	C6408 .16	1295.00
8M (V) Plate - for 135mm x 140mm box (5x5)	C6409 .03	1391.00	C6409 .16	1670.00
12M Plate - for 140mm x 210mm box (8x6)	C6412 .03	1663.00	C6412 .16	1997.00
14M Plate - for 140mm x 210mm box (8x6)	C6414 .03	1956.00	C6414 .16	2348.00
16M Plate - for 230x145mm box (10x6 or 9x6)	C6416 .03	2196.00	C6416 .16	2639.00
21M Plate - for 210mm x 210mm box (8x8)	C6421 .03	2524.00	C6421 .16	3030.00



C6401 .17 C6401 .26
C6401 .25



C6402 .17 C6402 .26
C6402 .25



C6403 .17 C6403 .26
C6403 .25

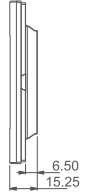

C6404 .17 C6404 .26
C6404 .25



C6406 .17 C6406 .26
C6406 .25

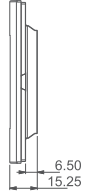

C6408 .17 C6408 .26
C6408 .25

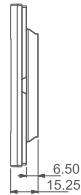

C6409 .17 C6409 .26
C6409 .25



C6412 .17 C6412 .26
C6412 .25

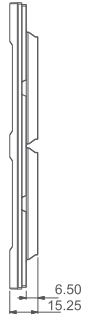

Images for 14M Plate, 16M Plate and 21M Plate are not shown here

CUBE Series

Flat'5 plates with frames Charcoal Black and Cocoa Brown

	Charcoal Black		Cocoa Brown	
	Cat no.	Price	Cat no.	Price
1M Plate - for 75mm x 75mm box (3x3)	C6401	.17 523.00	C6401	.25 523.00
2M Plate - for 75mm x 75mm box (3x3)	C6402	.17 602.00	C6402	.25 602.00
3M Plate - for 100mm x 75mm box (4x3)	C6403	.17 656.00	C6403	.25 656.00
4M Plate - for 135mm x 75mm box (5x3)	C6404	.17 704.00	C6404	.25 704.00
6M Plate - for 210mm x 75mm box (8x3)	C6406	.17 1212.00	C6406	.25 1212.00
8M Plate - for 230/210 x 75mm box (9x3 or 8x3)	C6408	.17 1314.00	C6408	.25 1314.00
8M (V) Plate - for 135mm x 140mm box (5x5)	C6409	.17 1761.00	C6409	.25 1761.00
12M Plate - for 140mm x 210mm box (8x6)	C6412	.17 2063.00	C6412	.25 2063.00
14M Plate - for 140mm x 210mm box (8x6)	C6414	.17 2394.00	C6414	.25 2394.00
16M Plate - for 230x145mm box (10x6 or 9x6)	C6416	.17 2792.00	C6416	.25 2792.00
21M Plate - for 210mm x 210mm box (8x8)	C6421	.17 3186.00	C6421	.25 3186.00

73

Flat'5 plates with frames Silver Dust

Description	Silver Dust	
	Cat no.	Price
1M Plate - for 75mm x 75mm box (3x3)	C6401	.26 523.00
2M Plate - for 75mm x 75mm box (3x3)	C6402	.26 602.00
3M Plate - for 100mm x 75mm box (4x3)	C6403	.26 656.00
4M Plate - for 135mm x 75mm box (5x3)	C6404	.26 704.00
6M Plate - for 210mm x 75mm box (8x3)	C6406	.26 1212.00
8M Plate - for 230/210 x 75mm box (9x3 or 8x3)	C6408	.26 1314.00
8M (V) Plate - for 135mm x 140mm box (5x5)	C6409	.26 1761.00
12M Plate - for 140mm x 210mm box (8x6)	C6412	.26 2063.00
14M Plate - for 140mm x 210mm box (8x6)	C6414	.26 2394.00
16M Plate - for 230x145mm box (10x6 or 9x6)	C6416	.26 2792.00
21M Plate - for 210mm x 210mm box (8x8)	C6421	.26 3186.00

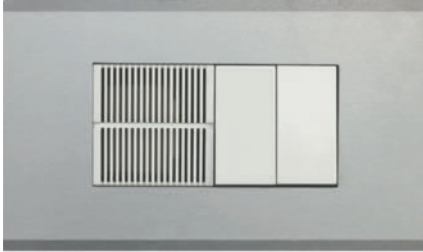

CA304 .04
Solid Aluminum Plate - 4 Module
natural finish mounted with
modules C5706 .01 and C5110 .01

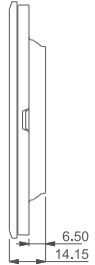

CA304 .05
Solid Aluminum Plate - 4 Module
black finish mounted with
C5706 .02, C5701 .02, C5726 .02

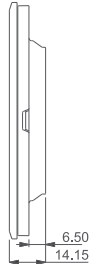

74



CA304 .14
Solid Aluminum Plate - 4 Module
Dark Bronze mounted with
modules C5110 .02 and C5721 .02

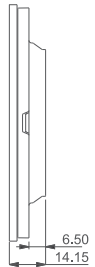

CUBE Series

Solid Aluminum Plates with frames Natural & Black

Description	Aluminum Natural		Aluminum Black	
	Cat no.	Price	Cat no.	Price
1M Plate - for 75mm x 75mm box (3x3)	CA301 .04	1902.00	CA301 .05	1902.00
2M Plate - for 75mm x 75mm box (3x3)	CA302 .04	1929.00	CA302 .05	1929.00
3M Plate - for 100mm x 75mm box (4x3)	CA303 .04	2046.00	CA303 .05	2046.00
4M Plate - for 135mm x 75mm box (5x3)	CA304 .04	2298.00	CA304 .05	2298.00
6M Plate - for 210mm x 75mm box (8x3)	CA306 .04	2516.00	CA306 .05	2516.00
8M Plate - for 230/210 x 75mm box (9x3 or 8x3)	CA308 .04	2725.00	CA308 .05	2725.00
8M (V) Plate - for 135mm x 140mm box (5x5)	CA309 .04	4960.00	CA309 .05	4960.00
12M Plate - for 140mm x 210mm box (8x6)	CA312 .04	6238.00	CA312 .05	6238.00
14M Plate - for 140mm x 210mm box (8x6)	CA314 .04	6786.00	CA314 .05	6786.00
16M Plate - for 230x145mm box (10x6 or 9x6)	CA316 .04	10152.00	CA316 .05	10152.00
21M Plate - for 210mm x 210mm box (8x8)	CA321 .04	13484.00	CA321 .05	13484.00

75

Solid Aluminum Plates with frames Dark Bronze

Description	Dark Bronze	
	Cat no.	Price
1M Plate - for 75mm x 75mm box (3x3)	CA301 .14	2091.00
2M Plate - for 75mm x 75mm box (3x3)	CA302 .14	2123.00
3M Plate - for 100mm x 75mm box (4x3)	CA303 .14	2251.00
4M Plate - for 135mm x 75mm box (5x3)	CA304 .14	2529.00
6M Plate - for 210mm x 75mm box (8x3)	CA306 .14	2768.00
8M Plate - for 230/210 x 75mm box (9x3 or 8x3)	CA308 .14	3000.00
8M (V) Plate - for 135mm x 140mm box (5x5)	CA309 .14	5455.00
12M Plate - for 140mm x 210mm box (8x6)	CA312 .14	6863.00
14M Plate - for 140mm x 210mm box (8x6)	CA314 .14	7428.00
16M Plate - for 230x145mm box (10x6 or 9x6)	CA316 .14	11169.00
21M Plate - for 210mm x 210mm box (8x8)	CA321 .14	14834.00

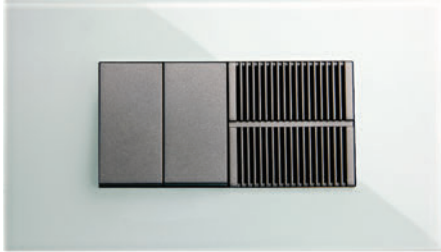

CG304 .08
Solid Glass Plate - 4 Module
ice white finish mounted with
modules C5110 .02 and C5706 .02

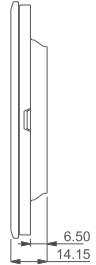

CG304 .09
Solid Glass Plate - 4 Module
metal gray finish mounted with
modules C5110 .01

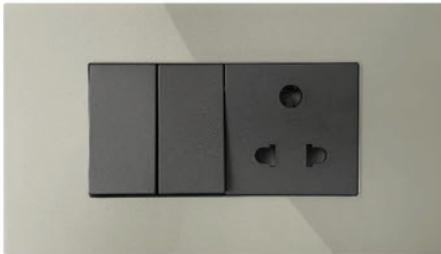
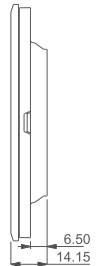

CG304 .18
Solid Glass Plate - 4 Module
Smoked Silver mounted with
modules C5110 .02 and C5212 .02

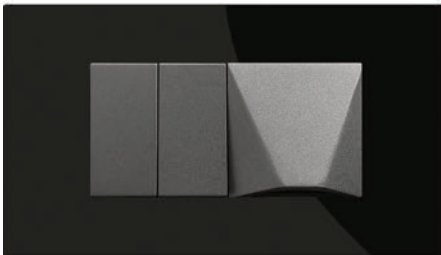
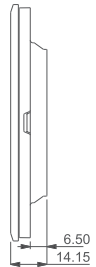

CG304 .19
Solid Glass Plate - 4 Module
Solid Black mounted with
modules C5110 .02 and C5271 .02

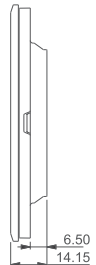

CUBE Series

Solid Glass Plates with frames Smoked Silver, Ice White & Metal Gray

Description	Ice White		Metal Gray		Smoked Silver	
	Cat no.	Price	Cat no.	Price	Cat no.	Price
1M Plate	CG301 .08	1361.00	CG301 .09	1361.00	CG301 .18	1361.00
2M Plate	CG302 .08	1382.00	CG302 .09	1382.00	CG302 .18	1382.00
3M Plate	CG303 .08	1465.00	CG303 .09	1465.00	CG303 .18	1465.00
4M Plate	CG304 .08	1646.00	CG304 .09	1646.00	CG304 .18	1646.00
6M Plate	CG306 .08	1801.00	CG306 .09	1801.00	CG306 .18	1801.00
8M Plate	CG308 .08	1951.00	CG308 .09	1951.00	CG308 .18	1951.00
8M (V) Plate	CG309 .08	2384.00	CG309 .09	2384.00	CG309 .18	2384.00
12M Plate	CG312 .08	3034.00	CG312 .09	3034.00	CG312 .18	3034.00
14M Plate	CG314 .08	3771.00	CG314 .09	3771.00	CG314 .18	3771.00
16M Plate	CG316 .08	5363.00	CG316 .09	5363.00	CG316 .18	5363.00
21M Plate	CG321 .08	6952.00	CG321 .09	6952.00	CG321 .18	6952.00

77

Solid Glass Plates with frames Solid Black, Ultra White & Frosted Ultra White

Description	Solid Black		Ultra White		Frosted Ultra White	
	Cat no.	Price	Cat no.	Price	Cat no.	Price
1M Plate	CG301 .19	1361.00	CG301 .38	1859.00	CG301 .48	2046.00
2M Plate	CG302 .19	1382.00	CG302 .38	1915.00	CG302 .48	2106.00
3M Plate	CG303 .19	1465.00	CG303 .38	2002.00	CG303 .48	2201.00
4M Plate	CG304 .19	1646.00	CG304 .38	2249.00	CG304 .48	2473.00
6M Plate	CG306 .19	1801.00	CG306 .38	2469.00	CG306 .48	2716.00
8M Plate	CG308 .19	1951.00	CG308 .38	2684.00	CG308 .48	2953.00
8M (V) Plate	CG309 .19	2384.00	CG309 .38	3259.00	CG309 .48	3586.00
12M Plate	CG312 .19	3034.00	CG312 .38	4147.00	CG312 .48	4561.00
14M Plate	CG314 .19	3771.00	CG314 .38	4726.00	CG314 .48	5199.00
16M Plate	CG316 .19	5363.00	CG316 .38	7328.00	CG316 .48	8062.00
21M Plate	CG321 .19	6952.00	CG321 .38	9500.00	CG321 .48	10451.00



CM304 .10
Solid Marble Finish Plate - 4 Module
Sparkle White finish mounted with
modules C5715 .01 and C5721 .01

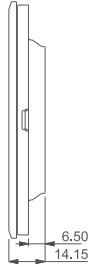

CM304 .11
Solid Marble Finish Plate - 4 Module
Terra Beige finish mounted with
modules C5110 .01 and C5900 .01



CM304 .12
Solid Marble Finish Plate - 4 Module
Salt White finish mounted with
modules C5739 .02 and C5723 .02

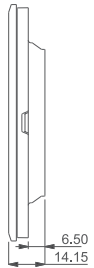

CM304 .13
Solid Marble Finish Plate - 4 Module
Onyx White finish mounted with
modules C5110 .02 and C5721 .02

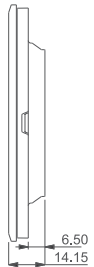

CUBE Series

Solid Marble Finish Plates with frames Sparkle White & Terra Beige

Description	Sparkle White		Terra Beige	
	Cat no.	Price	Cat no.	Price
1M Plate - for 75mm x 75mm box (3x3)	CM301 .10	1271.00	CM301 .11	1271.00
2M Plate - for 75mm x 75mm box (3x3)	CM302 .10	1291.00	CM302 .11	1291.00
3M Plate - for 100mm x 75mm box (4x3)	CM303 .10	1369.00	CM303 .11	1369.00
4M Plate - for 135mm x 75mm box (5x3)	CM304 .10	1537.00	CM304 .11	1537.00
6M Plate - for 210mm x 75mm box (8x3)	CM306 .10	1683.00	CM306 .11	1683.00
8M Plate - for 230/210 x 75mm box (9x3 or 8x3)	CM308 .10	1824.00	CM308 .11	1824.00
8M (V) Plate - for 135mm x 140mm box (5x5)	CM309 .10	2245.00	CM309 .11	2245.00
12M Plate - for 140mm x 210mm box (8x6)	CM312 .10	2896.00	CM312 .11	2896.00
14M Plate - for 140mm x 210mm box (8x6)	CM314 .10	3628.00	CM314 .11	3628.00
16M Plate - for 230x145mm box (10x6 or 9x6)	CM316 .10	4939.00	CM316 .11	4939.00
21M Plate - for 210mm x 210mm box (8x8)	CM321 .10	6250.00	CM321 .11	6250.00

79

Solid Marble Finish Plates with frames Salt White & Onyx White

Description	Salt White		Onyx White	
	Cat no.	Price	Cat no.	Price
1M Plate - for 75mm x 75mm box (3x3)	CM301 .12	1401.00	CM301 .13	1401.00
2M Plate - for 75mm x 75mm box (3x3)	CM302 .12	1421.00	CM302 .13	1421.00
3M Plate - for 100mm x 75mm box (4x3)	CM303 .12	1505.00	CM303 .13	1505.00
4M Plate - for 135mm x 75mm box (5x3)	CM304 .12	1691.00	CM304 .13	1691.00
6M Plate - for 210mm x 75mm box (8x3)	CM306 .12	1853.00	CM306 .13	1853.00
8M Plate - for 230/210 x 75mm box (9x3 or 8x3)	CM308 .12	2008.00	CM308 .13	2008.00
8M (V) Plate - for 135mm x 140mm box (5x5)	CM309 .12	2470.00	CM309 .13	2470.00
12M Plate - for 140mm x 210mm box (8x6)	CM312 .12	3186.00	CM312 .13	3186.00
14M Plate - for 140mm x 210mm box (8x6)	CM314 .12	3990.00	CM314 .13	3990.00
16M Plate - for 230x145mm box (10x6 or 9x6)	CM316 .12	5434.00	CM316 .13	5434.00
21M Plate - for 210mm x 210mm box (8x8)	CM321 .12	6876.00	CM321 .13	6876.00

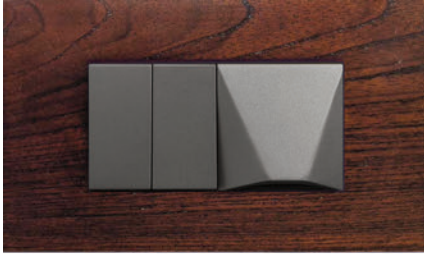

CW304 .06
Solid Wood Plate - 4 Module
dark mahogany mounted with
modules C5110 .02 and C5721 .02

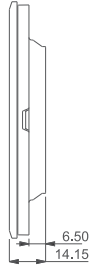

CW304 .07
Solid Wood Plate - 4 Module
natural pinewood mounted with
modules C5110 .01 and C5900 .01

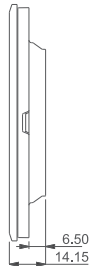

CW304 .29
Solid Wood Plate - 4 Module
walnut mounted with
modules C5110 .02 and C5212 .02

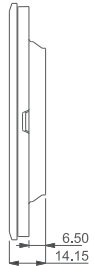

CUBE Series

Solid Wood Plates with frames Dark Mahogany & Natural Pinewood Polish

Description	Dark Mahogany		Pinewood	
	Cat no.	Price	Cat no.	Price
1M Plate - for 75mm x 75mm box (3x3)	CW301 .06	1382.00	CW301 .07	1382.00
2M Plate - for 75mm x 75mm box (3x3)	CW302 .06	1403.00	CW302 .07	1403.00
3M Plate - for 100mm x 75mm box (4x3)	CW303 .06	1487.00	CW303 .07	1487.00
4M Plate - for 135mm x 75mm box (5x3)	CW304 .06	1672.00	CW304 .07	1672.00
6M Plate - for 210mm x 75mm box (8x3)	CW306 .06	1831.00	CW306 .07	1831.00
8M Plate - for 230/210 x 75mm box (9x3 or 8x3)	CW308 .06	1982.00	CW308 .07	1982.00
8M (V) Plate - for 135mm x 140mm box (5x5)	CW309 .06	3164.00	CW309 .07	3164.00
12M Plate - for 140mm x 210mm box (8x6)	CW312 .06	4315.00	CW312 .07	4315.00
14M Plate - for 140mm x 210mm box (8x6)	CW314 .06	5034.00	CW314 .07	5034.00
16M Plate - for 230x145mm box (10x6 or 9x6)	CW316 .06	6951.00	CW316 .07	6951.00
21M Plate - for 210mm x 210mm box (8x8)	CW321 .06	8868.00	CW321 .07	8868.00

81

Solid Wood Plates with frames Walnut Polish

Description	Walnut	
	Cat no.	Price
1M Plate - for 75mm x 75mm box (3x3)	CW301 .29	1451.00
2M Plate - for 75mm x 75mm box (3x3)	CW302 .29	1473.00
3M Plate - for 100mm x 75mm box (4x3)	CW303 .29	1562.00
4M Plate - for 135mm x 75mm box (5x3)	CW304 .29	1755.00
6M Plate - for 210mm x 75mm box (8x3)	CW306 .29	1922.00
8M Plate - for 230/210 x 75mm box (9x3 or 8x3)	CW308 .29	2080.00
8M (V) Plate - for 135mm x 140mm box (5x5)	CW309 .29	3322.00
12M Plate - for 140mm x 210mm box (8x6)	CW312 .29	4531.00
14M Plate - for 140mm x 210mm box (8x6)	CW314 .29	5285.00
16M Plate - for 230x145mm box (10x6 or 9x6)	CW316 .29	7299.00
21M Plate - for 210mm x 210mm box (8x8)	CW321 .29	9312.00



D5212 .01



D5532 .01



D5531 .01



D5332 .01
D5732 .01



D5212 .02



D5532 .02



D5531 .02



D5332 .02
D5732 .02



82



D5212 .17



D5532 .17



D5531 .17



D5332 .17
D5732 .17



Integral Sockets can only be mounted on Special Flat'5 Plates suitable for mounting Integral Sockets. These plates are available in 2M & 4M sizes only. Colour options available in these plates are listed on the next page.

CUBE Series

Integral Sockets Frost White

Cat no.	Description	Price (Rs.)
D5212 .01	Integral Socket with Switch 6A 3+2 Pin [Round & Flat] Shuttered - 2M	686.00
D5532 .01	Integral Socket with Switch 13A International Multi Socket Shuttered- 2M	867.00
D5531 .01	Integral Socket with Switch 13A 3-Pin Flat Only Socket Shuttered - 2M	850.00
D5332 .01	Integral Socket with Switch 16A/6A 3-Pin Shuttered - 2 Module	878.00
D5732 .01	Integral Socket with Switch 25A/6A 3-Pin Shuttered - 2 Module	1179.00

Integral Sockets Quartz Gray

Cat no.	Description	Price (Rs.)
D5212 .02	Integral Socket with Switch 6A 3+2 Pin [Round & Flat] Shuttered - 2M	844.00
D5532 .02	Integral Socket with Switch 13A International Multi Socket Shuttered- 2M	1066.00
D5531 .02	Integral Socket with Switch 13A 3-Pin Flat Only Socket Shuttered - 2M	1044.00
D5332 .02	Integral Socket with Switch 16A/6A 3-Pin Shuttered - 2 Module	1081.00
D5732 .02	Integral Socket with Switch 25A/6A 3-Pin Shuttered - 2 Module	1421.00

83

Integral Sockets Charcoal Black

Cat no.	Description	Price (Rs.)
D5212 .17	Integral Socket with Switch 6A 3+2 Pin [Round & Flat] Shuttered - 2M	910.00
D5532 .17	Integral Socket with Switch 13A International Multi Socket Shuttered - 2M	1151.00
D5531 .17	Integral Socket with Switch 13A 3-Pin Flat Only Socket Shuttered - 2M	1127.00
D5332 .17	Integral Socket with Switch 16A/6A 3-Pin Shuttered - 2 Module	1168.00
D5732 .17	Integral Socket with Switch 25A/6A 3-Pin Shuttered - 2 Module	1564.00

Flat'5 Plates Suitable for Integral Sockets

D6402 .01	2M Plate - for 93mm x 95mm box (3x3) - Frost White	286.00
D6404 .01	4M Plate - for 93mm x 158mm box (3x5) - Frost White	545.00
D6402 .02	2M Plate - for 93mm x 95mm box (3x3) - Quartz Gray	506.00
D6404 .02	4M Plate - for 93mm x 158mm box (3x5) - Quartz Gray	972.00



D6402 .01	DG302 .08
D6402 .02	DG302 .09
D6402 .03	DG302 .18
D6402 .16	DG302 .19
D6402 .17	DG302 .38
D6402 .25	DG302 .48
D6402 .26	DM302 .10
DA302 .04	DM302 .11
DA302 .05	DM302 .12
DA302 .14	DM302 .13



D6404 .01	DG304 .08
D6404 .02	DG304 .09
D6404 .03	DG304 .18
D6404 .16	DG304 .19
D6404 .17	DG304 .38
D6404 .25	DG304 .48
D6404 .26	DM304 .10
DA304 .04	DM304 .11
DA304 .05	DM304 .12
DA304 .14	DM304 .13

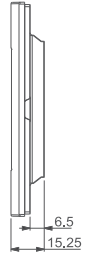

CUBE Series

contd...

D6402 .03	2M Plate - for 93mm x 95mm box (3x3) - Ice Silver	506.00
D6404 .03	4M Plate - for 93mm x 158mm box (3x5) - Ice Silver	972.00
D6402 .16	2M Plate - for 93mm x 95mm box (3x3) - Matt Gold	506.00
D6404 .16	4M Plate - for 93mm x 158mm box (3x5) - Matt Gold	972.00
D6402 .17	2M Plate - for 93mm x 95mm box (3x3) - Charcoal Black	506.00
D6404 .17	4M Plate - for 93mm x 158mm box (3x5) - Charcoal Black	972.00
D6402 .25	2M Plate - for 93mm x 95mm box (3x3) - Cocoa Brown	506.00
D6404 .25	4M Plate - for 93mm x 158mm box (3x5) - Cocoa Brown	972.00
D6402 .26	2M Plate - for 93mm x 95mm box (3x3) - Silver Dust	506.00
D6404 .26	4M Plate - for 93mm x 158mm box (3x5) - Silver Dust	972.00
DA302 .04	2M Plate - for 93mm x 95mm box (3x3) - Solid Aluminum Natural	2010.00
DA304 .04	4M Plate - for 93mm x 158mm box (3x5) - Solid Aluminum Natural	2473.00
DA302 .05	2M Plate - for 93mm x 95mm box (3x3) - Solid Aluminum Black	2010.00
DA304 .05	4M Plate - for 93mm x 158mm box (3x5) - Solid Aluminum Black	2473.00
DA302 .14	2M Plate - for 93mm x 95mm box (3x3) - Solid Aluminum Dark Bronze	2010.00
DA304 .14	4M Plate - for 93mm x 158mm box (3x5) - Solid Aluminum Dark Bronze	2473.00
DG302 .08	2M Plate - for 93mm x 95mm box (3x3) - Solid Glass Ice White	1402.00
DG304 .08	4M Plate - for 93mm x 158mm box (3x5) - Solid Glass Ice White	1726.00
DG302 .09	2M Plate - for 93mm x 95mm box (3x3) - Solid Glass Metal Gray	1402.00
DG304 .09	4M Plate - for 93mm x 158mm box (3x5) - Solid Glass Metal Gray	1726.00
DG302 .18	2M Plate - for 93mm x 95mm box (3x3) - Solid Glass Smoked Silver	1402.00
DG304 .18	4M Plate - for 93mm x 158mm box (3x5) - Solid Glass Smoked Silver	1726.00
DG302 .19	2M Plate - for 93mm x 95mm box (3x3) - Solid Glass Solid Black	1402.00
DG304 .19	4M Plate - for 93mm x 158mm box (3x5) - Solid Glass Solid Black	1726.00
DG302 .38	2M Plate - for 93mm x 95mm box (3x3) - Solid Glass Ultra White	1741.00
DG304 .38	4M Plate - for 93mm x 158mm box (3x5) - Solid Glass Ultra White	2143.00
DG302 .48	2M Plate - for 93mm x 95mm box (3x3) - Solid Glass Frosted Ultra White	1915.00
DG304 .48	4M Plate - for 93mm x 158mm box (3x5) - Solid Glass Frosted Ultra White	2357.00
DM302 .10	2M Plate - for 93mm x 95mm box (3x3) - Marble Finish Sparkle White	1369.00
DM304 .10	4M Plate - for 93mm x 158mm box (3x5) - Marble Finish Sparkle White	1682.00
DM302 .11	2M Plate - for 93mm x 95mm box (3x3) - Marble Finish Terra Beige	1369.00
DM304 .11	4M Plate - for 93mm x 158mm box (3x5) - Marble Finish Terra Beige	1682.00
DM302 .12	2M Plate - for 93mm x 95mm box (3x3) - Marble Finish Salt White	1369.00
DM304 .12	4M Plate - for 93mm x 158mm box (3x5) - Marble Finish Salt White	1682.00
DM302 .13	2M Plate - for 93mm x 95mm box (3x3) - Marble Finish Onix White	1369.00
DM304 .13	4M Plate - for 93mm x 158mm box (3x5) - Marble Finish Onix White	1682.00



DW302 .06
DW302 .07
DW302 .29



DW304 .06
DW304 .07
DW304 .29

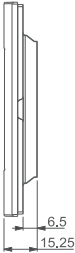

CUBE Series

contd...

DW302 .06	2M Plate - for 93mm x 95mm box (3x3) - Solid Wood Dark Mahagony	1489.00
DW304 .06	4M Plate - for 93mm x 158mm box (3x5) - Solid Wood Dark Mahagony	1831.00
DW302 .07	2M Plate - for 93mm x 95mm box (3x3) - Solid Natural Pinewood	1489.00
DW304 .07	4M Plate - for 93mm x 158mm box (3x5) - Solid Natural Pinewood	1831.00
DW302 .29	2M Plate - for 93mm x 95mm box (3x3) - Solid Wood Walnut	1563.00
DW304 .29	4M Plate - for 93mm x 158mm box (3x5) - Solid Wood Walnut	1922.00

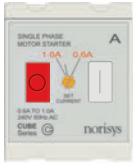

C525A .01

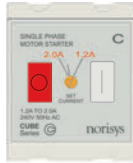

C525C .01



C525D .01

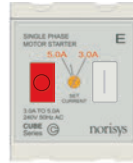

C525E .01

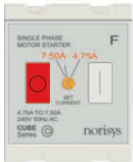

C525F .01



C525G .01



C525H .01



C525J .01



CTTSP06 .01



CTTSP10 .01



CTTSP16 .01



CTTSP20 .01



CTTSP25 .01



CTTSP32 .01

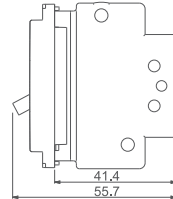

CTTDP06 .01
CTTDP10 .01



CTTDP16 .01
CTTDP20 .01



CTTDP25 .01
CTTDP32 .01



CLBDP32 .01
CLBDP50 .01

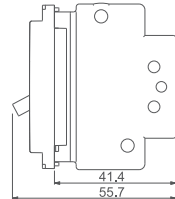

CUBE Series

Single Phase Motor Starters Frost White - for mounting with CUBE Series

Cat no.	Description		Price (Rs.)
C525A .01	Motor Starter 0.60 A - 1.00 A	1/8 HP Pump	961.00
C525B .01	Motor Starter 0.90 A - 1.50 A	1/4 HP Pump	961.00
C525C .01	Motor Starter 1.20 A - 2.00 A	1/3 HP Pump	961.00
C525D .01	Motor Starter 2.00 A - 3.50 A	1/2 HP Pump	961.00
C525E .01	Motor Starter 3.00 A - 5.00 A	3/4 HP Pump	961.00
C525F .01	Motor Starter 4.75 A - 7.50 A	1 Ton AC	961.00
C525G .01	Motor Starter 7.00 A - 11.50 A	1.5 Ton AC	961.00
C525H .01	Motor Starter 11.00 A - 18.00 A	2 Ton AC	998.00
C525J .01	Motor Starter 16.00 A - 25.00 A	2.5 Ton AC	1092.00

Tiny MCB Frost White - for mounting with CUBE Series

CTTSP06 .01	Tiny MCB Single Pole 6A	446.00
CTTSP10 .01	Tiny MCB Single Pole 10A	446.00
CTTSP16 .01	Tiny MCB Single Pole 16A	446.00
CTTSP20 .01	Tiny MCB Single Pole 20A	446.00
CTTSP25 .01	Tiny MCB Single Pole 25A	446.00
CTTSP32 .01	Tiny MCB Single Pole 32A	446.00
CTTDP06 .01	Tiny MCB Double Pole 6A	1112.00
CTTDP10 .01	Tiny MCB Double Pole 10A	1112.00
CTTDP16 .01	Tiny MCB Double Pole 16A	1112.00
CTTDP20 .01	Tiny MCB Double Pole 20A	1112.00
CTTDP25 .01	Tiny MCB Double Pole 25A	1112.00
CTTDP32 .01	Tiny MCB Double Pole 32A	1112.00

Tiny Load Break Switch Frost White - for mounting with CUBE Series

CLBDP32 .01	Tiny Load Break Switch Double Pole 32A	963.00
CLBDP50 .01	Tiny Load Break Switch Double Pole 50A	1068.00

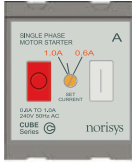

C525A .02

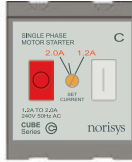

C525C .02

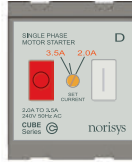

C525D .02

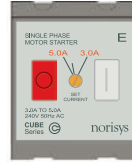

C525E .02

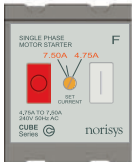
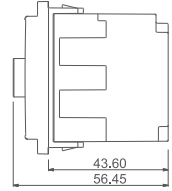

C525F .02



C525G .02

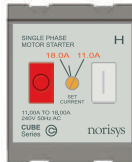

C525H .02

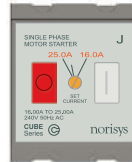

C525J .02

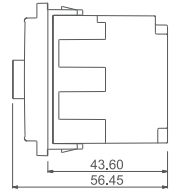

CTTSP06 .02



CTTSP10 .02



CTTSP16 .02



CTTSP20 .02



CTTSP25 .02



CTTSP32 .02

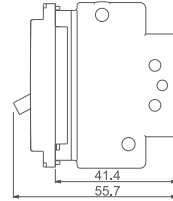

CTTDP06 .02
CTTDP10 .02



CTTDP16 .02
CTTDP20 .02



CTTDP25 .02
CTTDP32 .02



CLBDP32 .02
CLBDP50 .02

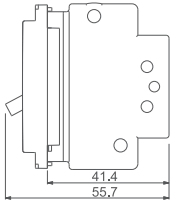

CUBE Series

Single Phase Motor Starters Quartz Gray - for mounting with CUBE Series

Cat no.	Description	Price (Rs.)
C525A .02	Motor Starter 0.60 A - 1.00 A 1/8 HP Pump	1193.00
C525B .02	Motor Starter 0.90 A - 1.50 A 1/4 HP Pump	1193.00
C525C .02	Motor Starter 1.20 A - 2.00 A 1/3 HP Pump	1193.00
C525D .02	Motor Starter 2.00 A - 3.50 A 1/2 HP Pump	1193.00
C525E .02	Motor Starter 3.00 A - 5.00 A 3/4 HP Pump	1193.00
C525F .02	Motor Starter 4.75 A - 7.50 A 1 Ton AC	1193.00
C525G .02	Motor Starter 7.00 A - 11.50 A 1.5 Ton AC	1193.00
C525H .02	Motor Starter 11.00 A - 18.00 A 2 Ton AC	1238.00
C525J .02	Motor Starter 16.00 A - 25.00 A 2.5 Ton AC	1353.00

Tiny MCB Quartz Gray - for mounting with CUBE Series

CTTSP06 .02	Tiny MCB Single Pole 6A	540.00
CTTSP10 .02	Tiny MCB Single Pole 10A	540.00
CTTSP16 .02	Tiny MCB Single Pole 16A	540.00
CTTSP20 .02	Tiny MCB Single Pole 20A	540.00
CTTSP25 .02	Tiny MCB Single Pole 25A	540.00
CTTSP32 .02	Tiny MCB Single Pole 32A	540.00
CTTDP06 .02	Tiny MCB Double Pole 6A	1358.00
CTTDP10 .02	Tiny MCB Double Pole 10A	1358.00
CTTDP16 .02	Tiny MCB Double Pole 16A	1358.00
CTTDP20 .02	Tiny MCB Double Pole 20A	1358.00
CTTDP25 .02	Tiny MCB Double Pole 25A	1358.00
CTTDP32 .02	Tiny MCB Double Pole 32A	1358.00

Tiny Load Break Switch Quartz Gray - for mounting with CUBE Series

CLBDP32 .02	Tiny Load Break Switch Double Pole 32A	1196.00
CLBDP50 .02	Tiny Load Break Switch Double Pole 50A	1324.00

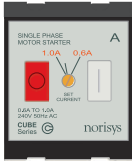

C525A .17

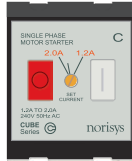

C525C .17

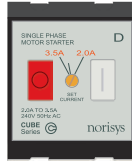

C525D .17

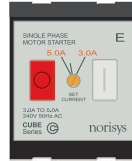

C525E .17

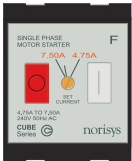
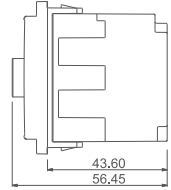

C525F .17



C525G .17



C525H .17

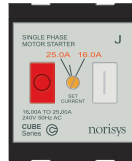

C525J .17



CTTSP06 .17



CTTSP10 .17



CTTSP16 .17



CTTSP20 .17



CTTSP25 .17



CTTSP32 .17

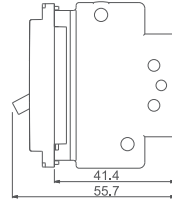

CTTDP06.17
CTTDP10.17



CTTDP16.17
CTTDP20.17



CTTDP25.17
CTTDP32.17

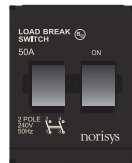

CLBDP32.17
CLBDP50.17

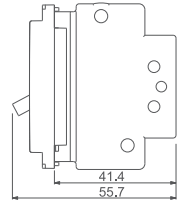

CUBE Series

Single Phase Motor Starters Charcoal Black - for mounting with CUBE Series

Cat no.	Description	Price (Rs.)
C525A .17	Motor Starter 0.60 A - 1.00 A 1/8 HP Pump	1300.00
C525B .17	Motor Starter 0.90 A - 1.50 A 1/4 HP Pump	1300.00
C525C .17	Motor Starter 1.20 A - 2.00 A 1/3 HP Pump	1300.00
C525D .17	Motor Starter 2.00 A - 3.50 A 1/2 HP Pump	1300.00
C525E .17	Motor Starter 3.00 A - 5.00 A 3/4 HP Pump	1300.00
C525F .17	Motor Starter 4.75 A - 7.50 A 1 Ton AC	1300.00
C525G .17	Motor Starter 7.00 A - 11.50 A 1.5 Ton AC	1300.00
C525H .17	Motor Starter 11.00 A - 18.00 A 2 Ton AC	1350.00
C525J .17	Motor Starter 16.00 A - 25.00 A 2.5 Ton AC	1476.00

Tiny MCB Charcoal Black - for mounting with CUBE Series

CTTSP06 .17	Tiny MCB Single Pole 6A	593.00
CTTSP10 .17	Tiny MCB Single Pole 10A	593.00
CTTSP16 .17	Tiny MCB Single Pole 16A	593.00
CTTSP20 .17	Tiny MCB Single Pole 20A	593.00
CTTSP25 .17	Tiny MCB Single Pole 25A	593.00
CTTSP32 .17	Tiny MCB Single Pole 32A	593.00
CTTDP06 .17	Tiny MCB Double Pole 6A	1480.00
CTTDP10 .17	Tiny MCB Double Pole 10A	1480.00
CTTDP16 .17	Tiny MCB Double Pole 16A	1480.00
CTTDP20 .17	Tiny MCB Double Pole 20A	1480.00
CTTDP25 .17	Tiny MCB Double Pole 25A	1480.00
CTTDP32 .17	Tiny MCB Double Pole 32A	1480.00

Tiny Load Break Switch Charcoal Black - for mounting with CUBE Series

CLBDP32 .17	Tiny Load Break Switch Double Pole 32A	1303.00
CLBDP50 .17	Tiny Load Break Switch Double Pole 50A	1445.00



S7110 .01
S7130 .01



S7210 .01
S7230 .01



S7111 .01
S7131 .01
S7731 .01



S7211 .01
S7231 .01



S7310 .01



S7311 .01

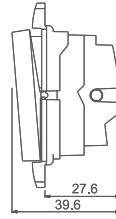

S7340 .01

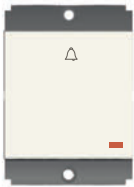

S7341 .01



S7180 .01



S7191 .01
S7171 .01

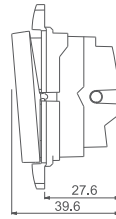

S8110 .01



S8210 .01



S8130 .01
S8730 .01



S8230 .01



S8310 .01



S8311 .01

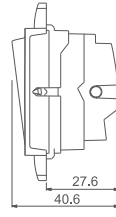

S8111 .01



S8211 .01



S8131 .01
S8731 .01



S8231 .01

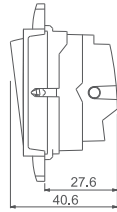

SQUARE Series

Switches Frost White

Cat no.	Description	Price (Rs.)
S7110 .01	Switch 6A One-way (Collarless Style) - 1 Module	105.00
S7111 .01	Switch 6A One-way with indicator (Collarless Style) - 1 Module	223.00
S7210 .01	Switch 6A Two-way (Collarless Style) - 1 Module	193.00
S7211 .01	Switch 6A Two-way with indicator (Collarless Style) - 1 Module	289.00
S7130 .01	Switch 16A One-way (Collarless Style) - 1 Module	238.00
S7131 .01	Switch 16A One-way with indicator (Collarless Style) - 1 Module	278.00
S7230 .01	Switch 16A Two-way (Collarless Style) - 1 Module	256.00
S7231 .01	Switch 16A Two-way with indicator (Collarless Style) - 1 Module	338.00
S7731 .01	Switch 25A One-way with indicator (Collarless Style) - 1 Module	402.00
S7310 .01	Switch 6A - Bell (Collarless Style) - 1 Module	203.00
S7311 .01	Switch 6A - Bell with indicator (Collarless Style) - 1 Module	262.00
S7340 .01	Palm Bell Switch 6A (Collarless Style) - 2 Module	263.00
S7341 .01	Palm Bell Switch 6A with indicator (Collarless Style) - 2 Module	297.00
S7180 .01	Palm Switch 6A One-way Double Pole (Collarless Style) - 2 Module	357.00
S7280 .01	Palm Switch 6A Two-way Double Pole (Collarless Style) - 2 Module	387.00
S7191 .01	Palm Switch 16A One-way DP with indicator (Collarless) - 2 Module	504.00
S7291 .01	Palm Switch 16A Two-way DP with indicator (Collarless) - 2 Module	594.00
S7171 .01	Palm Switch 25A One-way DP with indicator (Collarless) - 2 Module	600.00
S8110 .01	Switch 6A One-way (Collar Style) - 1 Module	93.00
S8111 .01	Switch 6A One-way with indicator (Collar Style) - 1 Module	211.00
S8210 .01	Switch 6A Two-way (Collar Style) - 1 Module	192.00
S8211 .01	Switch 6A Two-way with indicator (Collar Style) - 1 Module	278.00
S8130 .01	Switch 16A One-way (Collar Style) - 1 Module	229.00
S8131 .01	Switch 16A One-way with indicator (Collar Style) - 1 Module	262.00
S8230 .01	Switch 16A Two-way (Collar Style) - 1 Module	249.00
S8231 .01	Switch 16A Two-way with indicator (Collar Style) - 1 Module	343.00
S8730 .01	Switch 25A One-way (Collar Style) - 1 Module	302.00
S8731 .01	Switch 25A One-way with indicator (Collar Style) - 1 Module	376.00
S8310 .01	Switch 6A - Bell (Collar Style) - 1 Module	193.00
S8311 .01	Switch 6A - Bell with indicator (Collar Style) - 1 Module	248.00



S7213 .01



S7332 .01
S7732 .01



S7412 .01



S7532 .01
S7531 .01

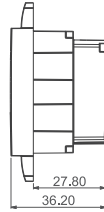

S1010 .01



S212 .01

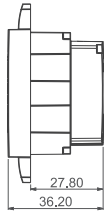

S7900 .01
S7910 .01
S7912 .01



S7901 .01
S7911 .01



S7913 .01



S7904 .01

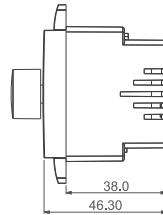

S7902 .01
S7903 .01



S7905 .01
S7908 .01

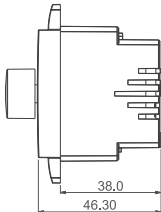

SQUARE Series

Sockets Frost White

Cat no.	Description	Price (Rs.)
S7213 .01	Socket 6A 3-Pin-only Shuttered - 2 Module (As per Indian Standard)	263.00
S7332 .01	Socket 16A/6A 3-Pin Shuttered - 2 Module (As per Indian Standard)	377.00
S7212 .01	Socket 6A 3+2 Pin [Round & Flat] Shuttered - 2 Module *	284.00
S7412 .01	Socket 6A 3+2 Pin And 2 pin Shuttered - 2 Module *	401.00
S1010 .01	Socket 6A 2 Pin [Round & Flat] - 1 Module *	189.00
S7532 .01	Socket 13A International Multi-Socket Shuttered - 2 Module *	377.00
S7531 .01	Socket 13A 3-Pin Flat Socket Shuttered - 2 Module *	366.00
S7732 .01	Socket 25A/6A 3-Pin Shuttered - 2 Module *	429.00

Fan Regulators & Dimmers Frost White

S7900 .01	Fan Regulator Step Type with Bar Knob for 80W fan - 2 Module	1007.00
S7901 .01	Fan Regulator Step Type with Round Knob for 80W fan - 2 Module	958.00
S7910 .01	Fan Regulator Step Type with Bar Knob for 120W fan - 2 Module	1107.00
S7911 .01	Fan Regulator Step Type with Round Knob for 120W fan - 2 Module	1054.00
S7912 .01	Fan Regulator 8-Step Type with Bar Knob for 120W fan - 2 Module	1129.00
S7913 .01	Fan Regulator 8-Step Type with Round Knob for 120W fan - 2 Module	1078.00
S7902 .01	Dimmer 500 Watts - 2 Module	796.00
S7903 .01	Dimmer 1000 Watts - 2 Module	1091.00
S7904 .01	Fan Regulator Single Module for 80W Fan - Step Type - 1 Module	561.00
S7905 .01	Dimmer 500 Watts - 1 Module	598.00
S7908 .01	Dimmer for LED Lights (3 wire system) - 1 Module	594.00

97

* Only for export outside India



S7797 .01



S7800 .01
S7101 .01



S7820 .01



S7600 .01



S7802 .01
S7100 .01



S7725 .01
S7736 .01

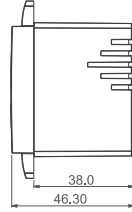

S7836 .01
S7837 .01



S7936 .01
S7938 .01



S7939 .01



S7729 .01

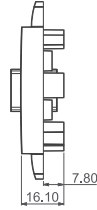

SQUARE Series

Communique' Frost White

Cat no.	Description	Price (Rs.)
S7797 .01	Coaxial T.V Socket - 1 Module	196.00
S7800 .01	Telephone Socket RJ-11 Double Line Shuttered - 1 Module	204.00
S7820 .01	Twin Telephone Socket RJ-11 - 1 Module	270.00
S7802 .01	Information Socket 6e - UTP Shuttered - 1 Module	688.00
S7100 .01	Information Socket 6a - UTP Shuttered - 1 Module	1182.00
S7725 .01	USB Extension Socket - 1 Module	541.00
S7736 .01	USB Charger Socket Outlet A Type- 2.1 Amps - 1 Module	2403.00
S7836 .01	USB Charger Socket Outlet C Type - 2.1 Amps - 1 Module	2657.00
S7936 .01	USB Charger Socket Outlet A+C Type - 2.1 Amps - 1 Module	2897.00
S7837 .01	USB Charger Socket Outlet C Type - 3.1 Amps - 1 Module	2837.00
S7938 .01	USB Charger Socket Outlet A+C Type - 3.1 Amps - 1 Module	3069.00
S7939 .01	USB Charger Socket Outlet C+C Type - 3.1 Amps - 1 Module	3211.00
S7729 .01	Computer Monitor Output Socket - 1 Module	352.00
S7101 .01	Fitment for RJ-45 Computer Socket Shuttered - 1 Module	218.00
S7600 .01	Indicator Light - 1 Module	125.00



S7232 .01



S7233 .01



S8232 .01



S8233 .01



S7262 .01

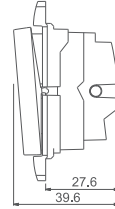

S7711 .01



S7450 .01

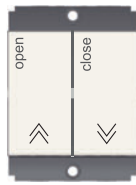

S7460 .01



S7500 .01

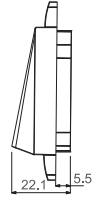

S7706 .01
S7707 .01
S7709 .01



S7721 .01



S7700 .01



S7798 .01

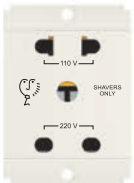
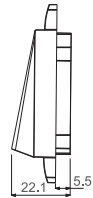

S7723 .01



S7719 .01



S7720 .01

SQUARE Series

Hospitality Modules Frost White

Cat no.	Description	Price (Rs.)
S7232 .01	"Do Not Disturb" Switch with indicator (Collarless Style) - 1 Module	385.00
S7233 .01	"Clean My Room" Switch with indicator (Collarless Style) - 1 Module	385.00
S8232 .01	"Do Not Disturb" Switch with indicator (Collar Style) - 1 Module	368.00
S8233 .01	"Clean My Room" Switch with indicator (Collar Style) - 1 Module	368.00
S7262 .01	Bell Switch with "Do Not Disturb" and "Clean My Room" indicator - 2M	623.00
S7711 .01	Call Bell Station with Register and Provision for External Buzzer - 2M	1475.00
S7719 .01	25A Key Fob Switch Double Pole with indicator - 2 Module	1200.00
S7720 .01	Key Fob - customized	213.00
S7723 .01	Shaver Socket 220V / 110V with transformer - 2 module	996.00
S7450 .01	Push Button Station Start - Stop (Collorless Style) - 2 Module	535.00
S7460 .01	Push Button Station Open - Close (Collorless Style) - 2 Module	595.00

101

Acoustic and Optical Signaling Frost White

S7706 .01	Speaker for audio music circuit - 2 Module	1202.00
S7707 .01	Electronic Bell - 2 Module	681.00
S7709 .01	Electronic Buzzer - 2 Module	609.00
S7721 .01	Step Marker Lamp / Night Lamp - 2 Module	628.00
S7798 .01	Audio Port / Jack 3.5mm - 1 Module	416.00

Support Modules Frost White

S7500 .01	Cord Outlet - 1 Module	135.00
S7700 .01	Blanking Plate - 1 Module	47.00



S7110 .23



S7210 .23



S7111 .23



S7211 .23



S7310 .23



S7311 .23

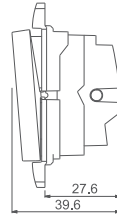

S7130 .23



S7230 .23



S7131 .23



S7731 .23



S7231 .23

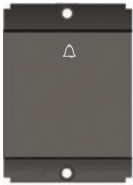
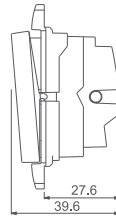

S7340 .23

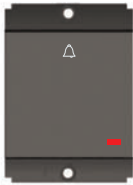

S7341 .23



S7180 .23



S7191 .23

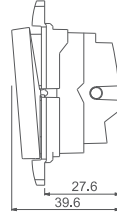

S7171 .23

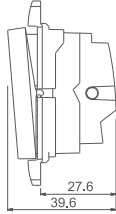

SQUARE Series

Switches Graphite Gray

Cat no.	Description	Price (Rs.)
S7110 .23	Switch 6A One-way (Collarless Style) - 1 Module	127.00
S7111 .23	Switch 6A One-way with indicator (Collarless Style) - 1 Module	277.00
S7210 .23	Switch 6A Two-way (Collarless Style) - 1 Module	238.00
S7211 .23	Switch 6A Two-way with indicator (Collarless Style) - 1 Module	356.00
S7130 .23	Switch 16A One-way (Collarless Style) - 1 Module	295.00
S7131 .23	Switch 16A One-way with indicator (Collarless Style) - 1 Module	344.00
S7230 .23	Switch 16A Two-way (Collarless Style) - 1 Module	318.00
S7231 .23	Switch 16A Two-way with indicator (Collarless Style) - 1 Module	411.00
S7731 .23	Switch 25A One-way with indicator (Collarless Style) - 1 Module	496.00
S7310 .23	Switch 6A - Bell (Collarless Style) - 1 Module	247.00
S7311 .23	Switch 6A - Bell with indicator (Collarless Style) - 1 Module	324.00
S7340 .23	Palm Bell Switch 6A (Collarless Style) - 2 Module	318.00
S7341 .23	Palm Bell Switch 6A with indicator (Collarless Style) - 2 Module	356.00
S7180 .23	Palm Switch 6A One-way Double Pole (Collarless Style) - 2 Module	430.00
S7280 .23	Palm Switch 6A Two-way Double Pole (Collarless Style) - 2 Module	462.00
S7191 .23	Palm Switch 16A One-way DP with indicator (Collarless) - 2 Module	606.00
S7291 .23	Palm Switch 16A Two-way DP with indicator (Collarless) - 2 Module	713.00
S7171 .23	Palm Switch 25A One-way DP with indicator (Collarless) - 2 Module	720.00



S7213 .23



S7332 .23
S7732 .23



S7412 .23



S7532 .23
S7531 .23

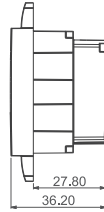

S1010 .23



S7212 .23

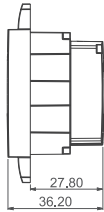

S7900 .23
S7910 .23
S7912 .23



S7901 .23
S7911 .23



S7913 .23



S7904 .23

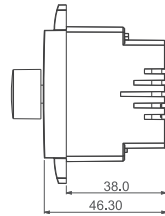

S7902 .23
S7903 .23



S7905 .23
S7908 .23

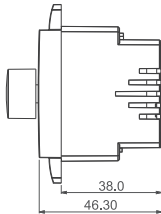

SQUARE Series

Sockets Graphite Gray

Cat no.	Description	Price (Rs.)
S7213 .23	Socket 6A 3-Pin-only Shuttered - 2 Module (As per Indian Standard)	319.00
S7332 .23	Socket 16A/6A 3-Pin Shuttered - 2 Module (As per Indian Standard)	459.00
S7212 .23	Socket 6A 3+2 Pin [Round & Flat] Shuttered - 2 Module *	341.00
S7412 .23	Socket 6A 3+2 Pin And 2 pin Shuttered - 2 Module *	481.00
S1010 .23	Socket 6A 2 Pin [Round & Flat] - 1 Module *	227.00
S7532 .23	Socket 13A International Multi-Socket Shuttered - 2 Module *	459.00
S7531 .23	Socket 13A 3-Pin Flat Socket Shuttered - 2 Module *	441.00
S7732 .23	Socket 25A/6A 3-Pin Shuttered - 2 Module *	515.00

Fan Regulators & Dimmers Graphite Gray

S7900 .23	Fan Regulator Step Type with Bar Knob for 80W fan - 2 Module	1208.00
S7901 .23	Fan Regulator Step Type with Round Knob for 80W fan - 2 Module	1151.00
S7910 .23	Fan Regulator Step Type with Bar Knob for 120W fan - 2 Module	1330.00
S7911 .23	Fan Regulator Step Type with Round Knob for 120W fan - 2 Module	1266.00
S7912 .23	Fan Regulator 8-Step Type with Bar Knob for 120W fan - 2 Module	1356.00
S7913 .23	Fan Regulator 8-Step Type with Round Knob for 120W fan - 2 Module	1294.00
S7902 .23	Dimmer 500 Watts - 2 Module	956.00
S7903 .23	Dimmer 1000 Watts - 2 Module	1311.00
S7904 .23	Fan Regulator Single Module for 80W Fan - Step Type - 1 Module	675.00
S7905 .23	Dimmer 500 Watts - 1 Module	719.00
S7908 .23	Dimmer for LED Lights (3 wire system) - 1 Module	713.00

* Only for export outside India



S7797 .23



S7800 .23
S7101 .23



S7820 .23



S7600 .23



S7802 .23
S7100 .23



S7725 .23
S7736 .23

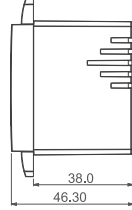

S7836 .23
S7837 .23



S7936 .23
S7938 .23



S7939 .23



S7729 .23

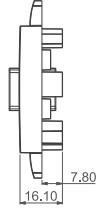

SQUARE Series

Communique' Graphite Gray

Cat no.	Description	Price (Rs.)
S7797.23	Coaxial T.V Socket - 1 Module	268.00
S7800.23	Telephone Socket RJ-11 Double Line Shuttered - 1 Module	245.00
S7820.23	Twin Telephone Socket RJ-11 - 1 Module	324.00
S7802.23	Information Socket 6e - UTP Shuttered - 1 Module	827.00
S7100.23	Information Socket 6a - UTP Shuttered - 1 Module	1430.00
S7725.23	USB Extension Socket - 1 Module	649.00
S7736.23	USB Charger Socket Outlet A Type- 2.1 Amps - 1 Module	2858.00
S7836.23	USB Charger Socket Outlet C Type - 2.1 Amps - 1 Module	3159.00
S7936.23	USB Charger Socket Outlet A+C Type - 2.1 Amps - 1 Module	3444.00
S7837.23	USB Charger Socket Outlet C Type - 3.1 Amps - 1 Module	3373.00
S7938.23	USB Charger Socket Outlet A+C Type - 3.1 Amps - 1 Module	3650.00
S7939.23	USB Charger Socket Outlet C+C Type - 3.1 Amps - 1 Module	3821.00
S7729.23	Computer Monitor Output Socket - 1 Module	422.00
S7101.23	Fitment for RJ-45 Computer Socket Shuttered - 1 Module	262.00
S7600.23	Indicator Light - 1 Module	150.00



S7232 .23



S7233 .23

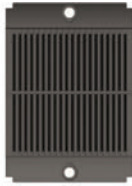

S7706 .23

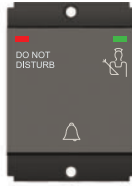

S7262 .23

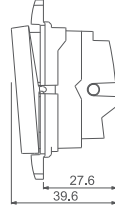

S7711 .23



S7450 .23



S7460 .23



S7500 .23

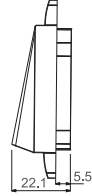

S7707 .23
S7709 .23



S7721 .23



S7700 .23



S7798 .23

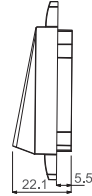

S7723 .23



S7719 .23



S7720 .23

SQUARE Series

Hospitality Modules Graphite Gray

Cat no.	Description	Price (Rs.)
S7232 .23	"Do Not Disturb" Switch with indicator (Collarless Style) - 1 Module	462.00
S7233 .23	"Clean My Room" Switch with indicator (Collarless Style) - 1 Module	462.00
S7262 .23	Bell Switch with "Do Not Disturb" and "Clean My Room" indicator - 2M	749.00
S7711 .23	Call Bell Station with Register and Provision for External Buzzer - 2M	1770.00
S7719 .23	25A Key Fob Switch Double Pole with indicator - 2 Module	1440.00
S7720 .23	Key Fob - customized	255.00
S7723 .23	Shaver Socket 220V / 110V with transformer - 2 module	1195.00
S7450 .23	Push Button Station Start - Stop (Collarless Style) - 2 module	642.00
S7460 .23	Push Button Station Open - Close (Collarless Style) - 2 module	716.00

Acoustic and Optical Signaling Graphite Gray

S7706 .23	Speaker for audio music circuit - 2 Module	1442.00
S7707 .23	Electronic Bell - 2 Module	818.00
S7709 .23	Electronic Buzzer - 2 Module	733.00
S7721 .23	Step Marker Lamp / Night Lamp - 2 Module	755.00
S7798 .23	Audio Port / Jack 3.5mm - 1 Module	499.00

109

Support Modules Graphite Gray

S7500 .23	Cord Outlet - 1 Module	161.00
S7700 .23	Blanking Plate - 1 Module	54.00



S7601 .01 S7601 .25
 S7601 .03 S7601 .27
 S7601 .23



S7602 .01 S7602 .25
 S7602 .03 S7602 .27
 S7602 .23

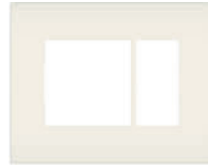

S7633 .01 S7633 .25
 S7633 .03 S7633 .27
 S7633 .23

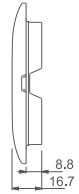

S7631 .01 S7631 .25
 S7631 .03 S7631 .27
 S7631 .23



S7632 .01 S7632 .25
 S7632 .03 S7632 .27
 S7632 .23



S7604 .01 S7604 .25
 S7604 .03 S7604 .27
 S7604 .23

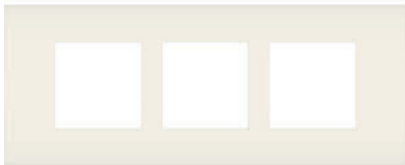
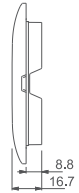

S7606 .01 S7606 .25
 S7606 .03 S7606 .27
 S7606 .23



S7608 .01 S7608 .25
 S7608 .03 S7608 .27
 S7608 .23



S7609 .01 S7609 .25
 S7609 .03 S7609 .27
 S7609 .23

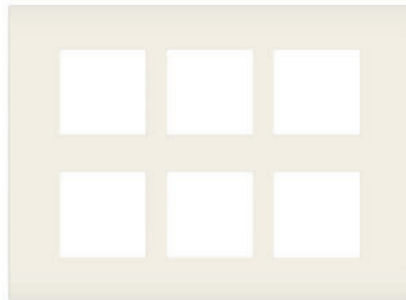

S7612 .01 S7612 .25
 S7612 .03 S7612 .27
 S7612 .23

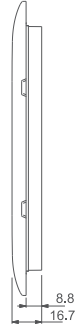

SQUARE Series

Smart Plates with frames Frost White and Wood Finish

Description	Frost White		Wood Finish	
	Cat no.	Price (Rs.)	Cat no.	Price (Rs.)
1M Plate - for 75mm x 75mm box (3x3)	S7601 .01	150.00	S7601 .27	497.00
2M Plate - for 75mm x 75mm box (3x3)	S7602 .01	150.00	S7602 .27	497.00
3M Plate - for 100mm x 75mm box (4x3)	S7633 .01	171.00	S7633 .27	562.00
1M Plate - for 100mm x 75mm box (4x3)	S7631 .01	171.00	S7631 .27	562.00
2M Plate - for 100mm x 75mm box (4x3)	S7632 .01	171.00	S7632 .27	562.00
4M Plate - for 135mm x 75mm box (5x3)	S7604 .01	187.00	S7604 .27	619.00
6M Plate - for 210mm x 75mm box (8x3)	S7606 .01	312.00	S7606 .27	1034.00
8M Plate - for 230mm x 75mm box (9x3)	S7608 .01	371.00	S7608 .27	1229.00
8M(V) Plate - for 135mm x 140mm box (5x5)	S7609 .01	435.00	S7609 .27	1441.00
12M Plate - for 140mm x 210mm box (8x6)	S7612 .01	515.00	S7612 .27	1707.00
18M Plate - for 210mm x 210mm box (8x8)	S7618 .01	674.00	S7618 .27	2235.00

111

Smart Plates with frames Graphite Gray, Cocoa Brown and Ice Silver

Description	Graphite Gray		Cocoa Brown		Ice Silver	
	Cat no.	Price (Rs.)	Cat no.	Price (Rs.)	Cat no.	Price (Rs.)
1M Plate	S7601 .23	216.00	S7601 .25	219.00	S7601 .03	219.00
2M Plate	S7602 .23	216.00	S7602 .25	219.00	S7602 .03	219.00
3M Plate	S7633 .23	244.00	S7633 .25	247.00	S7633 .03	247.00
1M Plate	S7631 .23	244.00	S7631 .25	247.00	S7631 .03	247.00
2M Plate	S7632 .23	244.00	S7632 .25	247.00	S7632 .03	247.00
4M Plate	S7604 .23	266.00	S7604 .25	270.00	S7604 .03	270.00
6M Plate	S7606 .23	444.00	S7606 .25	451.00	S7606 .03	451.00
8M Plate	S7608 .23	529.00	S7608 .25	538.00	S7608 .03	538.00
8M(V) Plate	S7609 .23	620.00	S7609 .25	631.00	S7609 .03	631.00
12M Plate	S7612 .23	734.00	S7612 .25	747.00	S7612 .03	747.00
18M Plate	S7618 .23	959.00	S7618 .25	978.00	S7618 .03	978.00



S725A .01

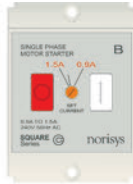

S725B .01



S725C .01

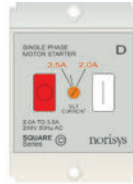

S725D .01



S725E .01



S725F .01



S725G .01



S725H .01

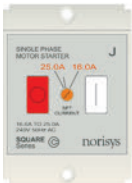

S725J .01



SQUARE Series

Single Phase Motor Starters Screw-mounting type - Frost White

Cat no.	Description		Price (Rs.)
S725A .01	Motor Starter 0.60 A - 1.00 A	1/8 HP Pump	833.00
S725B .01	Motor Starter 0.90 A - 1.50 A	1/4 HP Pump	833.00
S725C .01	Motor Starter 1.20 A - 2.00 A	1/3 HP Pump	833.00
S725D .01	Motor Starter 2.00 A - 3.50 A	1/2 HP Pump	833.00
S725E .01	Motor Starter 3.00 A - 5.00 A	3/4 HP Pump	833.00
S725F .01	Motor Starter 4.75 A - 7.50 A	1 Ton AC	833.00
S725G .01	Motor Starter 7.00 A - 11.50 A	1.5 Ton AC	833.00
S725H .01	Motor Starter 11.00 A - 18.00 A	2 Ton AC	869.00
S725J .01	Motor Starter 16.00 A - 25.00 A	2.5 Ton AC	945.00



STTSP06 .01



STTSP10 .01



STTSP16 .01



STTSP20 .01



STTSP25 .01



STTSP32 .01

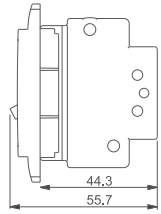

STTDP06 .01



STTDP10 .01



STTDP16 .01



STTDP20 .01

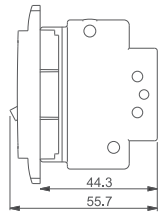

STTDP25 .01



STTDP32 .01



SLBDP32 .01



SLBDP50 .01

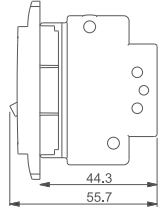

SQUARE Series

Tiny MCBs - Screw Mounting Type Frost White

Cat no.	Description	Price (Rs.)
STTSP06 .01	Tiny MCB Single Pole 6A	416.00
STTSP10 .01	Tiny MCB Single Pole 10A	416.00
STTSP16 .01	Tiny MCB Single Pole 16A	416.00
STTSP20 .01	Tiny MCB Single Pole 20A	416.00
STTSP25 .01	Tiny MCB Single Pole 25A	416.00
STTSP32 .01	Tiny MCB Single Pole 32A	416.00
STTDP06 .01	Tiny MCB Double Pole 6A	1036.00
STTDP10 .01	Tiny MCB Double Pole 10A	1036.00
STTDP16 .01	Tiny MCB Double Pole 16A	1036.00
STTDP20 .01	Tiny MCB Double Pole 20A	1036.00
STTDP25 .01	Tiny MCB Double Pole 25A	1036.00
STTDP32 .01	Tiny MCB Double Pole 32A	1036.00

115

Tiny Load Break Switch - Screw Mounting Type Frost White

SLBDP32 .01	Tiny Load Break Switch Double Pole 32A	885.00
SLBDP50 .01	Tiny Load Break Switch Double Pole 50A	967.00

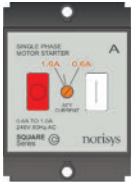

S725A .23



S725B .23



S725C .23



S725D .23



S725E .23



S725F .23



S725G .23



S725H .23



116



S725J .23

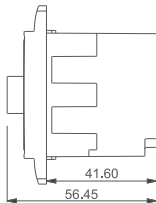

SQUARE Series

Single Phase Motor Starters Screw-mounting type - Graphite Gray

Cat no.	Description		Price (Rs.)
S725A .23	Motor Starter 0.60 A - 1.00 A	1/8 HP Pump	1010.00
S725B .23	Motor Starter 0.90 A - 1.50 A	1/4 HP Pump	1010.00
S725C .23	Motor Starter 1.20 A - 2.00 A	1/3 HP Pump	1010.00
S725D .23	Motor Starter 2.00 A - 3.50 A	1/2 HP Pump	1010.00
S725E .23	Motor Starter 3.00 A - 5.00 A	3/4 HP Pump	1010.00
S725F .23	Motor Starter 4.75 A - 7.50 A	1 Ton AC	1010.00
S725G .23	Motor Starter 7.00 A - 11.50 A	1.5 Ton AC	1010.00
S725H .23	Motor Starter 11.00 A - 18.00 A	2 Ton AC	1051.00
S725J .23	Motor Starter 16.00 A - 25.00 A	2.5 Ton AC	1143.00



STTSP06 .23



STTSP10 .23



STTSP16 .23



STTSP20 .23



STTSP25 .23



STTSP32 .23

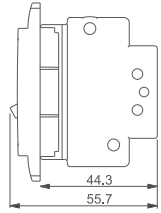

STTDP06 .23



STTDP10 .23



STTDP16 .23



STTDP20 .23

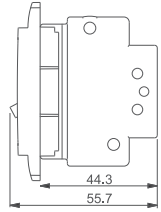

STTDP25 .23



STTDP32 .23

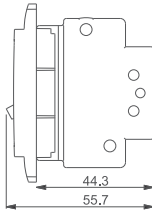

SLBDP32 .23



SLBDP50 .23

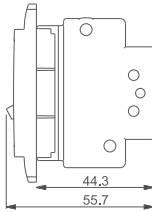

SQUARE Series

Tiny MCBs - Screw Mounting Type Graphite Gray

Cat no.	Description	Price (Rs.)
STTSP06 .23	Tiny MCB Single Pole 6A	504.00
STTSP10 .23	Tiny MCB Single Pole 10A	504.00
STTSP16 .23	Tiny MCB Single Pole 16A	504.00
STTSP20 .23	Tiny MCB Single Pole 20A	504.00
STTSP25 .23	Tiny MCB Single Pole 25A	504.00
STTSP32 .23	Tiny MCB Single Pole 32A	504.00
STTDP06 .23	Tiny MCB Double Pole 6A	1254.00
STTDP10 .23	Tiny MCB Double Pole 10A	1254.00
STTDP16 .23	Tiny MCB Double Pole 16A	1254.00
STTDP20 .23	Tiny MCB Double Pole 20A	1254.00
STTDP25 .23	Tiny MCB Double Pole 25A	1254.00
STTDP32 .23	Tiny MCB Double Pole 32A	1254.00

119

Tiny Load Break Switch - Screw Mounting Type Graphite Gray

SLBDP32 .23	Tiny Load Break Switch Double Pole 32A	1071.00
SLBDP50 .23	Tiny Load Break Switch Double Pole 50A	1170.00



PU3MFT .01



PU4MFT .01



PU6MFT .01



PU3MBT .01



PU4MBT .01



PU6MBT .01

SQUARE Series

Pre-wired Power Units Frost White

Cat no.	Description	Price (Rs.)
PU3MFT .01	Power Unit Flush Type with MCB + 25A Plug & Socket	1451.00
PU3MBT .01	Power Unit in Surface Box with MCB + 25A Plug & Socket	1638.00
PU4MFT .01	Power Unit Flush Type with Starter + 25A Plug & Socket	1894.00
PU4MBT .01	Power Unit in Surface Box with Starter + 25A Plug & Socket	2082.00
PU6MFT .01	Power Unit Flush Type with MCB + Starter + 25A Plug & Socket	2955.00
PU6MBT .01	Power Unit in Surface Box MCB + Starter + 25A Plug & Socket	3057.00



MB501 .01
SB501 .01



MB503 .01
SB503 .01



MB504 .01
SB504 .01



MB506 .01
SB506 .01



MB508 .01
SB508 .01



MB509 .01
SB509 .01

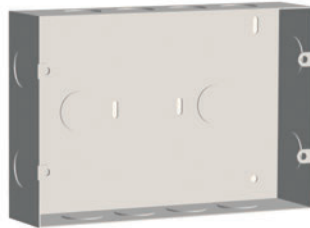

MB512 .01
SB512 .01



SM702 .01



SM703 .01

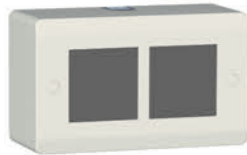

SM704 .01

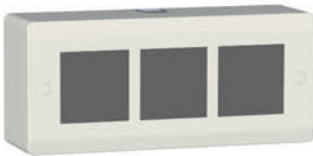

SM706 .01

Wiring Boxes

Superior Anti-Rust Stainless Steel Boxes Suitable for CUBE Series & SQUARE Series

Cat no.	Description	Suitable plate size in Cube Series	Suitable plate size in Square Series	Price (Rs.)
SB501 .01	75mm X 75mm X 50mm (3x3)	1M, 2M	1M, 2M	211.00
SB503 .01	100mm X 75mm X 50mm (4x3)	3M	1M, 2M, 3M	249.00
SB504 .01	135mm X 75mm X 50mm (5x3)	4M	4M	298.00
SB506 .01	210mm X 75mm X 50mm (8x3)	6M, 8M	6M	400.00
SB508 .01	230mm X 80mm X 50mm (9x3)	8M	8M	453.00
SB509 .01	135mm X 145mm X 50mm (5x5)	8M	8M	453.00
SB512 .01	145mm X 210mm X 50mm (8x6)	12M, 14M	12M	606.00
SB521 .01	210mm X 210mm X 50mm (8x8)	21M	18M	765.00

Metal Boxes Suitable for CUBE Series & SQUARE Series

123

MB501 .01	75mm X 75mm X 50mm (3x3)	1M, 2M	1M, 2M	133.00
MB503 .01	100mm X 75mm X 50mm (4x3)	3M	1M, 2M, 3M	164.00
MB504 .01	135mm X 75mm X 50mm (5x3)	4M	4M	200.00
MB506 .01	210mm X 75mm X 50mm (8x3)	6M, 8M	6M	281.00
MB508 .01	230mm X 80mm X 50mm (9x3)	8M	8M	315.00
MB509 .01	135mm X 145mm X 50mm (5x5)	8M	8M	315.00
MB512 .01	145mm X 210mm X 50mm (8x6)	12M, 14M	12M	447.00
MB521 .01	210mm X 210mm X 50mm (8x8)	21M	18M	570.00

Plastic Surface Boxes Frost White

SM702 .01	2 Module Surface Box 94mm X 94mm X 60mm (3.5 x 3.5)	246.00
SM703 .01	3 Module Surface Box 118mm X 94mm X 60mm (4.5 x 3.5)	278.00
SM704 .01	4 Module Surface Box 150mm X 94mm X 60mm (6 x 3.5)	325.00
SM706 .01	6 Module Surface Box 205mm X 94mm X 60mm (8 x 3.5)	384.00

CUBE Series exploded view

Solid, heavy products with fine precision engineering resulting in trouble-free operation.

Cover plate can be snap fit onto the frames after final painting of walls.

Strong and precise locks for sturdy mounting and easy removal.

124

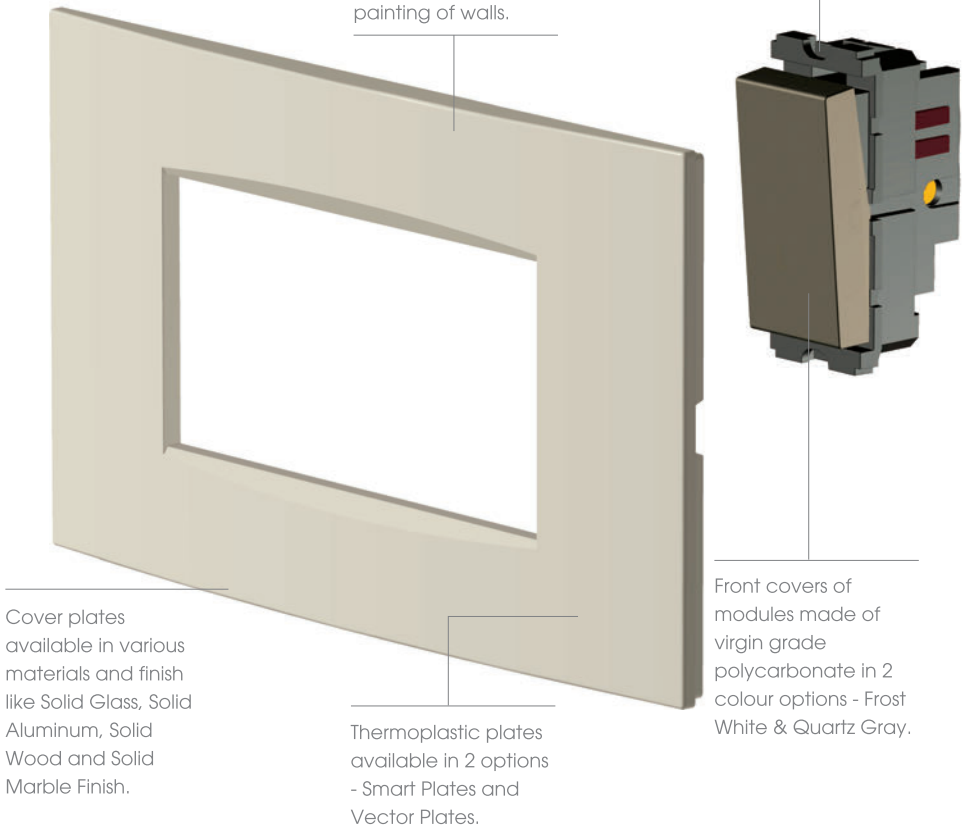

Thermoset material which can be seen in red colour is used inside to house the live metal parts. This material is extremely high heat resistant and does not melt on heating.

Sockets with elliptical spring loaded tubes for a firm and uniform grip on the plug pins ensuring unwavering contact.

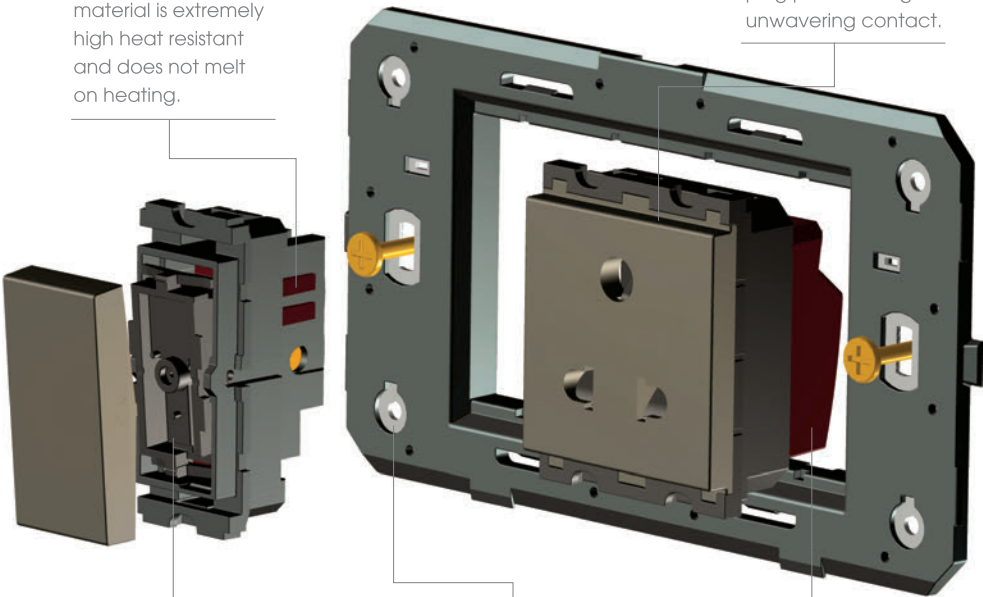

Inner shield for extra safety. It prevents the arcing from coming in contact with the front rocker. Also muffles the operating sound.

Bi-material frames that have high quality steel embedded inside thermoplastic. A result of advanced engineering, this combination leads to extra stiffness and tight tolerances for mounting of modules.

Live metal parts in sockets are enclosed in a housing made of thermoset material which is extremely high heat resistant and is capable of handling higher operating currents.

SQUARE Series exploded view

Time tested products which have evolved over a period of time - with the latest in technology.

Cover plate can be snap fit onto the frames after final painting of walls.

Modules are mounted on the frame using screws making it a fool-proof and durable mounting system.

126

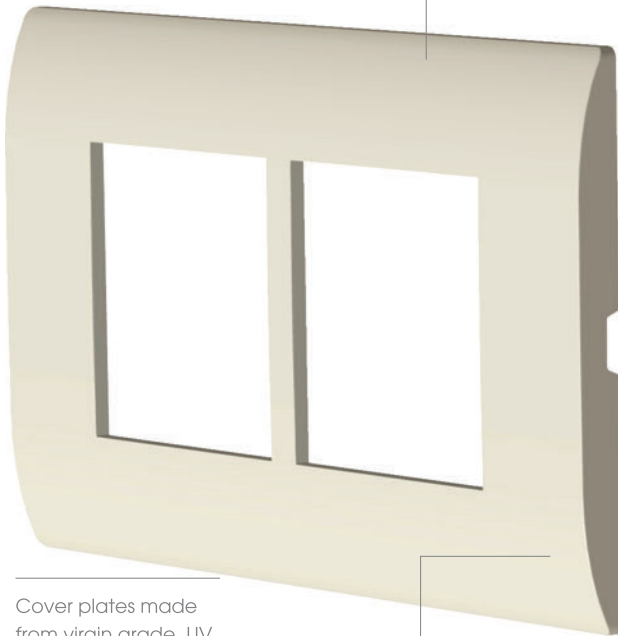

Cover plates made from virgin grade, UV stabilized polycarbonate for a flawless glossy look that lasts longer.

Smart Plates that have a classic contour profile - a look unwavered by changes in fashion.

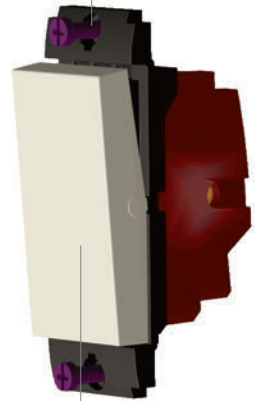

Front covers of modules made of virgin grade polycarbonate.

Thermoset material which can be seen in red colour is used inside to house the live metal parts. This material is extremely high heat resistant and does not melt on heating.

Sockets with elliptical spring loaded tubes for a firm and uniform grip on the plug pins ensuring unwavering contact.

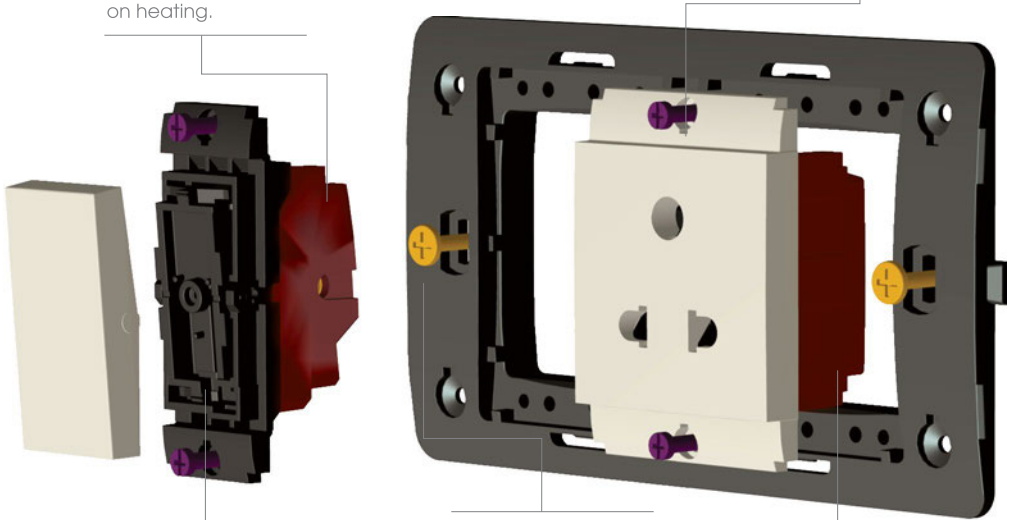

Inner shield for extra safety. It prevents the arcing from coming in contact with the front rocker. Also muffles the operating sound.

Tough frames that have unique locator slots that guide the modules to its accurate mounting location - thus ensuring uniform gaps in fitment. Steel channels at the rear give additional strength to the frames for rigidity.

Live metal parts in sockets are enclosed in thermoset material that is extremely high heat resistant and is capable of handling higher operating currents.

norisys[®]



@All rights reserved. Norisys is a registered trademark.

Wiring of electrical products should be done by trained professionals following all safety norms.

@Alle Rechte vorbehalten. Norisys ist eine eingetragene Marke.

Elektroinstallationen dürfen nur von entsprechend ausgebildeten Fachkräften unter Beachtung der maßgeblichen Sicherheitsrichtlinien vorgenommen werden.

Headquarters

Norisys Technology Private Limited
14/3 Mathura Road
Faridabad - 121 003, India

CIN: U31101DL1987PTC026630

Toll free: 1 800 11 1617

Tel: +91 11 49126360, 42657036

WhatsApp: +91 88 003 97858

Email: sales@norisys.com

Web: www.norisys.com